



# ULTIMHEAT

## HEAT & CONTROLS



# INDUSTRIAL JACKET HEATERS FOR METAL, PLASTIC & GLASS CONTAINERS

- Silicon heaters:
- Immersion heaters:

See catalogue No.25

See catalogue No.22

Contact us





Because of permanent improvement of our products, drawings, descriptions, features used on these data sheets are for guidance only and can be modified without prior advice

Section 1	Summary	P1-4
Section 2	Historical introduction	P1-42
	Technical introduction	P43-66
Section 3	References list	P1-4

<b>Antifreeze jacket heaters</b>		<b>P1-6</b>
----------------------------------	--	-------------

Section 4		9VJ32	Antifreeze Jacket heaters for 18L (5 gallons), 23L (6 gallons), 30L (8 US gallons), 60L (30 US gallons), 110L (30 US gallons) <b>glass</b> carboy, <b>plastic</b> buckets and <b>plastic</b> drums. <b>Non-adjustable thermostat set at 5°C</b> , mounted on cable connection box. Surface temperature limited to <b>65°C</b> . <b>10mm</b> thickness insulation foam.	P3-4
		9VJ22	Antifreeze Jacket heaters for 110L (30 US gallons), 210L (55US gallons) and 1000L IBC. <b>Non-adjustable thermostat set at 5°C</b> , mounted on cable connection box. Surface temperature limited to <b>65°C</b> . <b>20mm</b> thickness insulation foam.	P5-6



<b>Jacket heaters with surface mounted fixed setting temperature control</b>		<b>P1-6</b>
--	--	-------------





Section 5		9VJV6	Fixed temperature Jacket heaters for 18L (5 gallons), 23L (6 gallons), 30L (8 US gallons), 60L (30 US gallons), 110L (30 US gallons) <b>glass</b> carboy, <b>plastic</b> buckets and <b>plastic</b> drums. Surface temperature limited to <b>65°C</b> . <b>10mm</b> thickness insulation foam.	P3-4
		9VJF6	Fixed temperature Jacket heaters for 110L (30 US gallons), 210L (55US gallons) and 1000L IBC. Surface temperature limited to <b>65°C</b> . <b>20mm</b> thickness insulation foam.	P5-6

<b>Jacket heaters with adjustable electronic temperature control for plastic containers heating</b>		<b>P1-6</b>
---	--	-------------

Section 6		9VJMA	Jacket heaters for 18L (5 Gallons), 23L (6 gallons), 30L (8 gallons), 60L <b>glass</b> carboy and <b>plastic</b> buckets. Miniature electronic temperature control with 4-40°C knob <b>mounted on jacket</b> . Surface temperature limited to <b>65°C</b> . <b>10mm</b> thickness insulation foam	P3-4
		9VJEF	Jacket heaters for 18L (5 Gallons), 23L (6 gallons), 30L (8 gallons), 60L <b>glass</b> carboy and <b>plastic</b> buckets. <b>Remote</b> electronic temperature control with digital display. Surface temperature limited to <b>65°C</b> . <b>20 mm</b> thickness insulation foam.	P5-6



Jacket heaters with adjustable electronic temperature control for metal drums heating				P1-8
Section 7		9VJAE 9VJAD	Jacket heaters for 110L (30 US gallons) and 210L (55US gallons) <b>metal</b> drums. <b>Surface mounted</b> electronic thermostat, with 20-125°C knob adjustment or digital display controller. Surface temperature limited to <b>135°C</b> . <b>20 mm</b> thickness insulation foam.	P3-6
		9VJAF	Jacket heaters for 110L (30 US gallons) and 210L (55US gallons) <b>metal</b> drums. <b>Remote</b> electronic temperature control, with digital display. Surface temperature limited to <b>135°C</b> . <b>20 mm</b> thickness insulation foam.	P7-8

Jacket heaters with adjustable electronic temperature control for 1000L IBC (Industrial bulk containers)				P1-12
Section 8		9VJDA	Jacket heaters for 1000L IBC ( <b>Plastic containers with tubular steel frame</b> ). <b>One</b> heating zone. Miniature electronic thermostat, adjustment by 4-40°C knob, mounted on jacket surface. <b>Surface</b> temperature limited to <b>65°C</b> . Thermal insulation by <b>20mm</b> foam.	P3-4
		9VJDF	Jacket heaters for 1000L IBC ( <b>Plastic containers with tubular steel frame</b> ). <b>One</b> heating zone. <b>Remote</b> electronic temperature control with <b>digital display</b> . Surface temperature limited to <b>65°C</b> . Thermal insulation by <b>20mm</b> foam.	P5-6
		9VJBE 9VJBD	Jacket heaters for 1000L IBC ( <b>Plastic containers with tubular steel frame</b> ). <b>Two independent</b> heating zones. Temperature control by electronic thermostat with knob 20 to 125°C or by controller with <b>digital display</b> , mounted on jacket <b>surface</b> . Surface temperature limited to <b>135°C</b> . Thermal insulation by <b>20mm</b> foam.	P7-10
		9VJBF	Jacket heaters for 1000L IBC ( <b>Plastic containers with tubular steel frame</b> ). <b>Two independent</b> heating zones. <b>Remote</b> electronic temperature control with <b>digital display</b> . Surface temperature limited to <b>135°C</b> . Thermal insulation by <b>20mm</b> foam.	P11-12



Because of permanent improvement of our products, drawings, descriptions, features used on these data sheets are for guidance only and can be modified without prior advice



Because of permanent improvement of our products, drawings, descriptions, features used on these data sheets are for guidance only and can be modified without prior advice

Complementary insulating accessories				P1-10
Section 9		9V2C	Insulation lids (without heating), with or without orifices for stirrers and temperature sensors	P3-5
		9V2E	Insulation pedestals (without heating),	P6-7
		9V2D	Insulation jackets (without heating)	P8-9
Complementary heating accessories				P1-8
Section 10		9V3	Insulation jackets with heat transfer fluid tubular circuit (heating or cooling)	P3-4
		9V4	Base heaters	P5
		9SWR2	3000 W Immersion heaters for 1000 liters IBC, Stainless steel, IP65, with temperature control thermostat, and safety against dry run.	P6-8
Safety, control and temperature homogenization				P1-8
Section 11		Y8WTZ 9H060	Stirrer speed controller with IP65 enclosure; Compact full stainless steel stirrer for drums and IBC.	P3-4
		Y8WH-E	Digital display liquid temperature controller with NTC 500mm long temperature sensing probe for temperature measurement at the centre of containers.	P5



Section 11		Y8WJ-F	Double digital display PID temperature controller with NTC 500mm long temperature sensing probe for temperature measurement at the centre of containers	P6
		TNR80 TSR80	500mm long immersed probe temperature sensors, NTC or Pt100 for drums and IBC	P7
		Y8WSY	20mA, 20A ground fault breaker inside IP69K enclosure.	P8

## Special products

P1-4

Section 12		Products made on order: special dimensions, industrial blanket heaters, high temperature models a.s.o.	P3
------------	---	--	----



---

# Historical introduction

Because of permanent improvement of our products, drawings, descriptions, features used on these data sheets are for guidance only and can be modified without prior advice



Because of permanent improvement of our products, drawings, descriptions, features used on these data sheets are for guidance only and can be modified without prior advice





## Historical introduction

### Historical introduction to electric flexible heating elements also under the following names:

**In the medical field:** Thermal Bands, Electric Compress, Thermal Knee Brace, Thermaplasma, Thermoplasma.

**In household appliances:** Electric footmuff, Flexible bed warmer, Bed warmer, Foot warmer, Heating pad, Heating blanket, Heating blanket, Heating blanket, Heating net, Heating mantle, Heating blanket, Heating carpet, Heating footstools, Heating mat, Heated wall hang, Electric thermophile.

**In industry and horticulture:** Heating cord, Thermophilic electrothermal wires, Heating strips, Heating fabric, Heavy duty fabric, Heating strips.

**In the automotive and aeronautics fields:** Car heater, Heated overalls, Heated gloves, Heated vest, Heated knitwear, Heated clothes.

### Part one: Emergence and evolution of flexible heating elements

The arrival of these devices in the very last years of the 19th century is linked to the convergence of several technological developments:

- The development of medical science, and the study of the effects of heat on the treatment of certain diseases (particularly rheumatism and neuralgia)
- The weaving of asbestos threads in braids around a heating wire
- The progress of wire drawing techniques, making it possible to produce threads with small diameters, to the order of a tenth of a millimeter
- Improvement of refining processes for nickel and its alloys, making it malleable.
- The development of domestic electrical distribution.

Weaving asbestos, which was named “bright flax” or “salamander wool” by old alchemists, had been known of since ancient times. The arrival of gas heaters in the second half of the 19th century, developed the use of wicks or tufts in heated homes. (1857 Marini, Industrial Engineering).

For a long time, asbestos was the only “textile” resistant to the temperature of heating resistance wires. Around 1882, the Bender and Martini factories in Turin started to produce flexible asbestos braids. (October 1892 Asbestos in Italy, Industrial Engineering)

1887: Mr. Geoffroy [Saint Hilaire] has succeeded in braiding an incombustible asbestos cloth around the metal wires that insulates them, and has made it impossible for them to catch fire, even when the current is high enough to melt them.

(1887 Dictionary of Electricity and Magnetism, Etymological, Historical, Theoretical, Technical by Ernest Jacquez)

In 1892, asbestos was used as insulation around the electric heating wires of electric soldering irons (1892 Nature, electric heating), and the first electric heaters were made from platinum wires surrounded by asbestos. (1896 Teymon, journal of useful knowledge N° 46).

Although the first asbestos-insulated electric heaters had only fixed and rigid heating elements, the availability of braided and flexible asbestos made it possible to develop flexible heating elements.

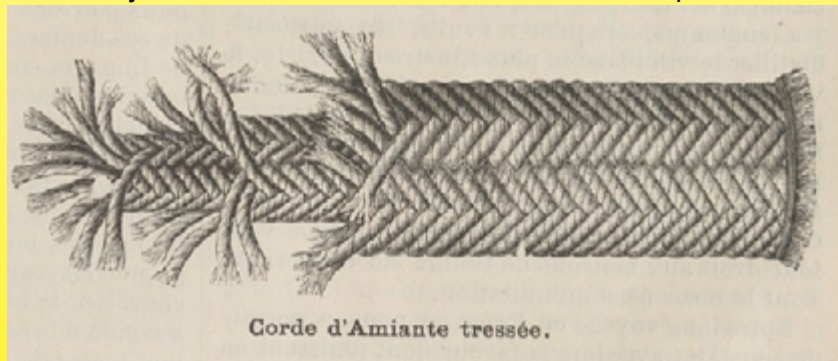

Asbestos cord braided by Bender and Martini (October 1892, Asbestos in Italy, Industrial Engineering)

Nickel is malleable and therefore can only be stretched when it is pure. For a long while, it was a laboratory curiosity without being applied industrially. The discovery of nickel mines in New Caledonia by Jules Garnier, who patented a refining process and built a plant in Septeme in the Bouches du Rhone region alongside Henri Marbeau, made it possible to produce 98% pure nickel as early as 1878. (1938 Nickel Story by Joseph Dhavernas, Ultimheat Museum). The industrial development of its use took place when soldiers noticed an increase in armor resistance when nickel

was added to steel, and when some states replaced silver and copper with nickel.

Henri Marbeau's founding of the “Fonderie de Nickel et Métaux Blancs” factory in Lizy sur Ourcq, which in 1884 became “Le Ferro Nickel”, made it possible to produce malleable nickel for heating elements. (1884 Le Ferro Nickel, Ultimheat Museum)

From the very beginning of electric heating, we have been preoccupied with incorporating resistors into fabrics and supplying them with a power current, so as to make them caloric, due to the rise in temperature produced in them.

“However, a few tests were carried out to create fabrics; firstly, electrical conductors were fixed to the surface of ordinary flame-retardant fabrics, and these wires were woven together with those of an asbestos fabric. As a result, devices such as heating rheostats for high temperature, and heated carpets and wall coverings were produced”. ( 1910 Industrial Review: Monthly Technical and Economic Review)

## 1893-1913: The arrival of heated fabric for medical use

It seems that the first “flexible” heating fabrics were used in 1893 by Dr. S. Salaghi, Professor of Physics at the Faculty of Medicine in Bologna. They were showcased at the International Medical Exhibition held in Rome in 1894, for the International Congress of Medicine. They were powered from the country’s national grid, and a switch allowed them to operate at various power levels.

Dr. S. Salaghi named them ‘electrical thermoplasms’.

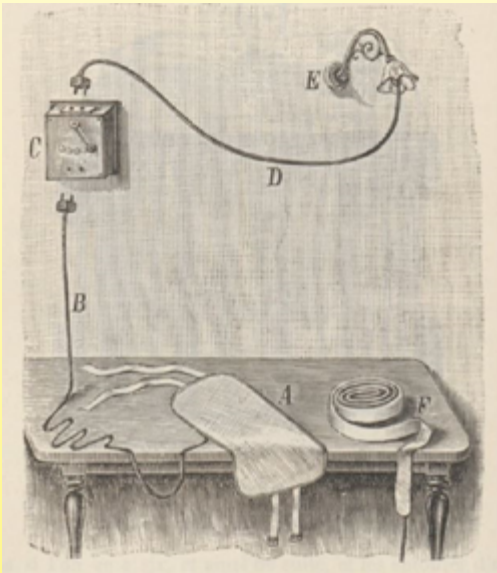

Thermoplasm by Dr. S. Salaghi (1893). Available in an oval shape (A) for trunk heating, and in long strips (F) for head-to-toe applications.

The first tests on heated fabric were made in France by Charles Camichel, while he was a lecturer at the Faculty of Sciences of Lille, from 1895 to 1900, where he taught industrial electricity. The results of the tests he conducted were satisfactory, but the weight and stiffness of the heating fabric prevented them from being applied to clothes making. On the other hand, the insulation was often imperfect, creating possible danger, or the resistance to wear was insufficient, or the metal of the heating element rusted quickly. As a result of all these disadvantages, the idea of industrially manufacturing heated fabric was abandoned as it was seen as insufficiently practical.

These devices used heating wire sewn onto an asbestos support or onto canvas formed by a resistant wire frame, insulated with asbestos, and covered with a simple cloth.

Producing heated fabrics that came into contact with the skin came with major constraints: the surface temperature could not exceed 60-70°C, which occurred when the maximum power was around 0.04 W/cm<sup>2</sup>. This required the use of heating wires with a high linear resistance, which was obtained by decreasing the diameter of the wires as much as possible. The consequence of this was the use of long heating wires. For an average power of 50 watts at 110 volts, using the lowest diameter of existing wires on the market (0.1mm), it was necessary to use about 20 m of tinned iron wire (the most

common resistive wire available at the time), 15m if it was constantan, and up to 110m for copper.

One example of the heating fabric of this era, which was invented by the American John Emory Meek, under patent No. 540398 dated June 4, 1895, described a rudimentary weaving method using asbestos warp and weft yarns in conductive metal.

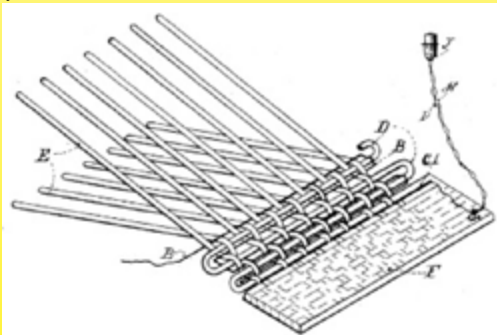

June 4, 1895, U.S. Patent No. 540398, John Emory Meek in Denver, for Johns Manufacturing Cy of New York, described a heating fabric whose warp yarns (E) are made of asbestos, and weft yarns (B) made of conductive metal, with a second asbestos interlayer weft (D). The two ends of the heating element (F) do not include a heating wire.

In 1896 Camille Herrgott (1), a civil engineer, began making heating blankets and clothing. An only child, at the age of 3 he lost his father, Camille Herrgott, who was an engineer for the Forges d’Audincourt company. His mother left Audincourt with her son for Le Valdoie where her sister-in-law Joséphine Hergott, wife of Michel Page, founder of Ets Page, lived in Valdoie. There they built, amongst other equipment, copper drawing machines.

(Directory of the Historical Society of the Thann-Guebwiller regions, 1985 T16, by Joseph Baumann), (1) (Joseph, Michel, Camille Herrgott born August 31, 1870 in Audincourt Doubs, died July 16, 1942 in Valdoie, Territoire-de-Belfort. Married in Valdoie, April 19, 1904 at the age of 34 to Marie Agathe Thérèse Riss (1881-1971) with whom he had 4 children in 1905, 1906, 1909, and 1916)

In 1897 calorific equipment was not very well known in Paris, although a few interesting experiments were made around the Place de Clichy area. In London, a similar device called an electric compress was being used, which in fact was simply an asbestos mattress which patients found worked well.

(Report from the Paris City Council on the electrification and evolution of electrical appliances, 1897)



## Historical introduction

After 5 years of development from 1896 to 1901, in January 1902 in France, England and Germany, and in the US in August of that year, Camille Herrgott, filed a patent for heated fabric that he named 'electric Thermophile', a term that remained in use for over 30 years.

These patents described **two basic features** of all flexible heating elements made thereafter:

The first, which was used on heating cords, describes the method of winding heating wire on a textile insulating core, making it possible to increase the length of heating wire per meter of heating cord. Up until this point, the technique of winding a very fine and very resistant thread on a single insulating wire (asbestos), produced a heating wire that was too big and too rigid for weaving, and it was only possible to apply it on fabrics such as metal wires. In 1910, after many developments, this technique made it possible to produce a heating cord with a very small diameter, consisting of a flat braid of pure nickel thread spiraled around a woolen core. This heating wire then received two spiral wraps, wound in opposite directions, formed from thin fabric guipures. In this way, a flexible thread could be obtained, which did not buckle, and where the traction went against the wool threads and the outer guipures, and not via the thermal threads.

This technique of manufacturing heating cords went on to be universally used in heated blankets in the middle of the 20th century.



Heating cord (patented by Camille Herrgott, 1901). A = heating wire; B = textile core; C = outside wrapping wound in the opposite direction of the heating wire

The second innovation of this patent consisted in manual or mechanical fabric weaving using a non-combustible wire support chain and a heat-resistant wire frame.

This technique was not new (see Meek patent above), but until then the heating wire loops in the heads and selvages, through their wear, caused short circuits and cut-outs. Camille Hergott, using his coiled heating wire, stopped the thermal wires outside these areas. He created the current leads with special wires, one in each selvage, placed after weaving. This assembly made it possible to make circuit clusters in 'shunt' or in series. The heating wires were woven between two layers of insulating weft wire. As early as 1904, this technique made it possible to produce carpets and blankets, as well as medical equipment. They were equipped with a thermal safety unit, consisting of a eutectic fuse at 70°C. The use of nickel, which he substituted around 1910 for other metal wires, particularly those of iron, made the whole system stainless and rustproof. It took all the technical expertise of an engineer from a wire drawing plant to make nickel wire with a 0.1mm diameter (Even today, the commercial stretching of nickel wire does not drop below 0.025mm in diameter). In this section, a length of approximately 20m of nickel heating wire was required to achieve a 50W resistance, which could cover a heating fabric surface of 350x350mm. In addition, pure nickel, whose resistivity greatly increases with temperature, gave the system a self-regulating function. It is indeed easy to calculate that the power of a 50 watt nickel heating element at room temperature drops to 36W at 100°C and 26W at 200°C.

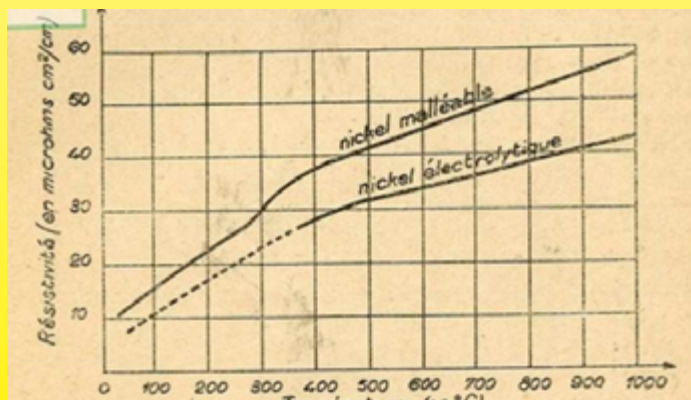

Variation of nickel resistivity according to temperature: self-regulating effect. (1945 Modern Electrotechnical Materials, Ultimheat Museum)

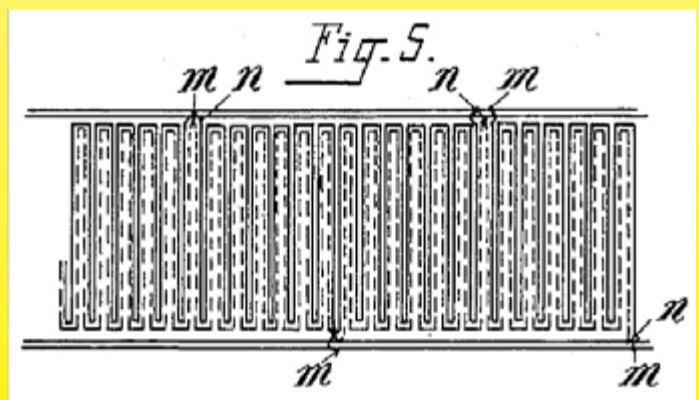

m, n: Detail of the connections on the supply wires in the selvages. This technique is still used today in electrical tracing (patented by Camille Herrgott in 1901).

# Historical introduction



In 1902, Dr. Jules Larat at the Paris Children's Hospital, was the first in France to use a heating fabric for medical applications:

"The thermoplasm consists of two separate parts; a heating pad and a control unit. The unit has a lever and a series of contacts that allow a gradual change from 40 to 100°C. A small indicator lamp lights up as soon as the current passes, and increases in brightness as a portion of the heat being developed in the compress. The latter is mounted on a flexible wire, and it is easy to apply the heating pad in the evening when going to bed. It can be kept on all night without the temperature varying in any way. There are many applications of this device, the only drawback of which is that it can only be operated economically where electric lighting is already present. It can be used in all cases where heat therapy is required: rheumatism, neuralgia, etc. (Report of the Academy of Medicine, session dated January 21st, 1902.)

The heating element itself is formed of mica blades wound with a calculated resistance wire. The blades are interconnected by an insulated flexible wire and protected by a wrap of asbestos cloth and a bag of fleece and silk. The purpose of these wraps is to distribute heat evenly over the entire surface of the compress and avoid cooling. The latter can be made for all kinds of purposes: slippers, knee pads, belts, bands, etc. (Fashion and beauty, December 1902)

In January 1902, Larat created the Larat and Dutar General Partnership in order to operate a medication system called « Dr. Larat's Thermoplasm ».

In April 1903, as a result of the descriptions given on these new applications, the company of the former Parvillée brothers and Co., known for their electric heating and cooking appliances, exhibited a range of electric appliances for medicine, including an electric thermoplasm or poultice compress, consisting of an incombustible asbestos cloth, in the folds of which a resistant conductor was placed. The appliance included the thermoplasm itself and a regulator.

The regulator was connected through a marble socket and a green flexible wire to a bayonet cap, which was introduced to replace the incandescent lamp.

The thermoplasm was then connected to the regulator by a wire. Position 0 was stop, positions 1, 2, 3 and 4 corresponded to 4 different degrees of heat, gradually increasing from No. 1 (minimum) to No. 4 (maximum). This apparatus also came in the form of a heating mat.

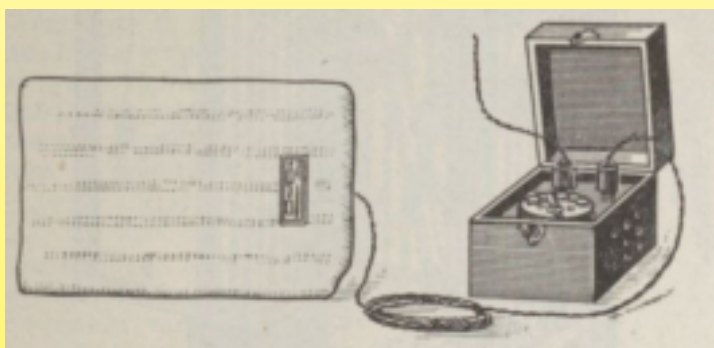

'Thermoplasme Parvillée' 1903. Dimensions 25cm x 35cm Power: "Less than that of 5 candle lamps" or about 50 watts (at this time). The surface charge was around 0.06 W/cm<sup>2</sup>.

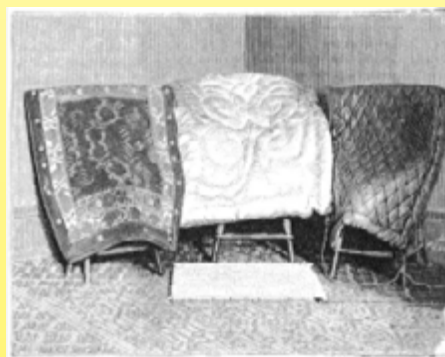

By 1904, Camille Hergott had commercially released heating carpets and electric blankets using the technology of his inventions (1904, La Nature, Ultimheat Collection)



Inside view of the heating mat, top left - wires crossed by the current, bottom right - power socket (1904, La Nature, Ultimheat collection)

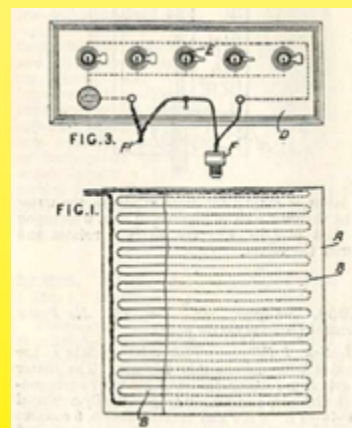

In England in 1906, RF Lafoon put forward the concept of adjusting the power by placing parallel warning lamps on the resistors (Patent dated October 13)

Because of permanent improvement of our products, drawings, descriptions, features used on these data sheets are for guidance only and can be modified without prior advice



The heated fabrics of Camille Hergott were, from then on, widely discussed in the scientific press which looked at future developments in "Electrically heated clothing". Mr Hergott, from Valdoie-Belfort, has just created heated fabrics which, if the public is interested, could revolutionize the art of dressing and heating oneself. It consists of fabric heated through electricity running through it or rather through a network of wires cleverly inserted into the fabric. I do, however, have hope of seeing these fabrics appear one day in real clothing, which in my opinion would have serious economic advantages, since it would no longer be a question of heating up the rather considerable volume of air contained in a room, but only the much smaller area around the body. In trams, we would only need to attach a patch to a bench to feel gentle and comforting heat. And why not on the street as well? We could invent a kind of small platform with an electric motor, connected to a plug, to keep people warm" (The New Labor Regulations: Health and Safety in Commerce and Industry, 1906)

In 1907, during the annual exhibition of medical devices in Paris, from April 3 to 5, Georges André Félix Goisot exhibited flexible appliances for electrical heating (Medical Electricity Archives, April 10, 1907). The first tests of his heating fabrics showed how delicate his single-conductor heating wires were, and he filed a patent the same year, describing cords composed of several conductors, although these had already been patented by Hergott.

In 1909, the techniques developed by Camille Hergott earned him a gold medal at the International Exhibition of East France in Nancy, and in May 17, 1910, a praiseworthy report presented by D'Arsonval to the Academy of Sciences (Weekly Reports from Sessions of the Academy of Sciences, 1910-05-17, p 1234). He handed the distribution and manufacture of household appliances to Paz and Silva (Paris) and those for medical use to G. Gaiffe (Paris). He kept the manufacture of equipment for industrial use (drying filters, mobile conveyor belts) at La Sablière at Valdoie, near Belfort.



Heated clothing for medical use by Hergott, 1910 (Medical electricity archives, August 25, 1910)  
Here we can clearly see the existence of sewn heating cord patches.

**Uses of heated fabric for medical use developed, and in 1913, the following was written:** "I used the Hergott electric heating system sold by Gaiffe and Paz and Silva. These "Hergott thermophilic" fabrics, presented to the Academy of Sciences by D'Arsonval, studied by Bergonié, from Bordeaux, with all his recognized skill, have recently been the subject of a glowing report by Daniel Berthelot at the French Society for Encouraging National Industry. They have the dual advantage of acting as heat insulators in the same way as clothes and blankets, and of being heat generators whose action is completely regular. The fine pure nickel wires which make up the heating elements were wound on a textile core and wrapped in a covering. The system is large enough for its constituent parts to be knitted by hand or mechanically woven. The heating part is lined with an ordinary woolen knit that protects it and is also used to hold the wires bringing current to the resistor. Due to the nature of the metal wires through which the current travels, their resistivity increases considerably with temperature. The thermophiles themselves are their own regulator: the more they heat, the less electricity they consume. The experiments of Daniel Berthelot achieved absolute safety when operating these devices. He has introduced various measures that prevent short-circuits and irregular heating from occurring. As for the heat produced by the Hergott fabrics, it could vary from 40 to 150 degrees, according to Berthelot. I used these heating compresses a number of times and I have always obtained extremely satisfactory results."

Collection of past papers on surgery and orthopedics 1913-11

## 1912-1917: The beginning of household warming blankets, industrial heating fabrics, and electrical household heating fabrics

In 1912, 10 years after the patents of Camille Herrgott, and 8 years after the commercialization of his blankets, an American doctor named Sidney I Russel created a flexible mattress heater, called the “underblanket” which credited him in the USA as the “inventor of electric blankets.”

That same year, 1912, Camille Hergott received a silver-gilt medal from the Society for the Encouragement of National Industry, to reward him for the many years he spent developing heating fabrics. (Bulletin of the National Society for the Encouragement of National Industry, February <sup>1</sup>. 1913, P218.)

**1913** Most of the reported difficulties were overcome by Belfort engineer Mr C Herrgott. The fabric he invented triumphed over all the tests imposed on him by the reporter in charge of his technical examination. He also performed impressively in the practical tests carried out in a Bordeaux hospital, under the direction of Professor Bergonié. Mr. Daniel Berthelot noted the clear superiority of Herrgott’s fabric on tests involving a weft of electrical conductors or an asbestos frame supporting spiral wires. The conductors are an integral part of the fabric, and their presence does not reduce any of its indispensable flexibility. The metal chosen to make them is pure nickel, whose resistance to oxidation is well known. Between two neighboring wires, the potential difference is too small to risk a short-circuit, and the insulation ensures that water sprinkled on the fabric does not create any abnormal heating. To prevent any possible accident, the inventor also chose not to extend the conductive network to the edges of the fabric, so that any wear would not lead the metal to become exposed. Finally, ordinary sockets allow the fabric to connect to 110 or 220 volts, as would be the case for a simple lamp.

Report submitted by Mr. Daniel Berthelot to the Society for the Encouragement of National Industry, (Bulletin of the National Society for the Encouragement of National Industry, February <sup>1</sup>. 1913, P218)

1924 Le Correspondant: monthly magazine covering religion, philosophy, and politics

<https://gallica.bnf.fr/ark:/12148/bpt6k415185c/f882.item.r=%22C%20Herrgott%22.texteImage>

## 1914-1918: Military clothing for heating and their post-war automotive applications

In 1914, Camille Herrgott was awarded a major prize in Lyon.

When the first world war broke out, he was 44 years old. The class of 1890, which he belonged to, was called up in 1915.

L’Ouest éclair, November 14, 1915 “German guards heated with electricity” On November 13 in Zurich, the Leipziger Neuste reported on a curious invention by German professors Bech and Chroter: Electric heating used to keep guards warm.

This invention consists of briefs and vests with insulated conductive flexible wire. These threads do not prevent freedom of movement, and the weight of the underpants is only increased by 850 grams. They are coated with waterproof fabric, which insulates the source of the electric power, which keeps the guards warm. This power source is not on the person, therefore it is not necessary to use a portable battery, such as those found in small

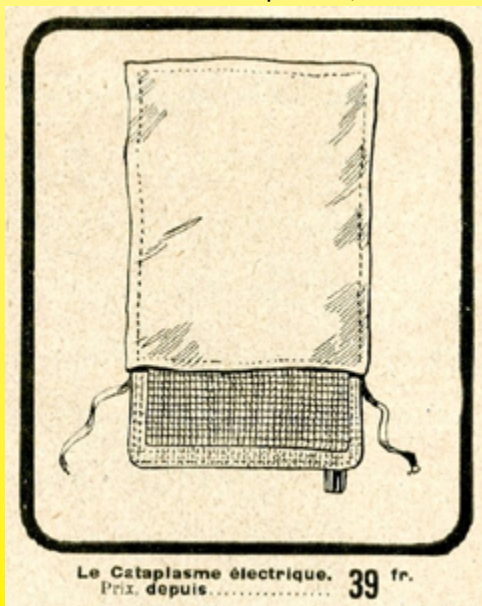

electric lamps. The guard is connected to a small electrical power unit, found in all advanced positions, and wire refractors are used for high-voltage obstacles. The guard using it reroutes a small wire that connects the generator, whose power is reduced by the transformer. It is calculated that it is very easy to use this method at 500 meters. A contact allows the guard to operate or stop the current if the heat becomes excessive. The cost of these briefs and the whole system is 125 Francs.

L’Ouest éclair, November 17, 1915.

Dear Mr. Director, I am reading an article in today’s Ouest-Eclair entitled “German Guards Heated with Electricity.” I cannot help but speak up when I see Professors Bech and Chroten claiming that they invented devices that were being made in France a few years before I left for Tunisia, which was around 1907. At that time, one of our friends, Mr. Hergott, an engineer from Chaudet-Page, in Valdoie (near Belfort), was manufacturing heating mats for apartments, warming blankets and heating vests that could be used in parks or by a river bank, even several hundred meters from the electricity source. All these fabrics were incombustible and have effectively been used. Mr. Hergott told me that he had filed patents in France and Germany, and that he had sold some of his appliances to Parisian stores.

November 1916 Paz & Silva Electric Poultice Compress by Camille Hergott



# Historical introduction

Because of permanent improvement of our products, drawings, descriptions, features used on these data sheets are for guidance only and can be modified without prior advice

During the 1<sup>st</sup> World War, developments in aircraft performance, e.g. flying at higher altitudes, particularly above 4,000 to 5,000 meters, gave rise to the need for heated clothing. In April 1918, heated suits were part of a pilot's equipment. Unlike heated medical clothing made before the war by Camille Hergott, they were powered by low voltage. This was the specialist field of manufacturer G. Goisot (Boulevard Gouvion, Saint Cyr in Paris).

"Also, during the last war, we used clothes and underwear heated by electricity. This heating is produced by threads sewn under fabric sheaths inside clothes. These wires are slightly heated. This mode of heating is essential for keeping all parts of men active during cold weather. The main items of clothing were gloves, slippers, helmets, knee pads and bibs. Cars, to their favour, employ this system, as the two wires that conduct the current produced by the dynamo to the wireless devices are used for heated clothing" 1920 Sciences and voyages N° 26.

In April 1916, André Aimé Lemerrier filed a patent in France (No. 468588) and in the USA for electric heated gloves and other heated clothing. He was the son of Charles François Ernest Lemerrier who, before 1910, specialized in clothing for aviators. At the end of the war, he joined forces with his brother Henri Gaston to create the company Lemerrier brothers. Because of their original trades, they were the first to create electrically heated fabrics before making other household electrical appliances. With their expertise in aviation, the Lemerrier brothers continued until the end of the Second World War to manufacture heated suits for aviators, and had a textile business manufacturing parachutes.

Lemerrier's involvement in the field of heated fabric had begun in 1913, according to Henry Letorey in his work "I offer you health, cheerfulness, and well-being; I am the electricity fairy", published in 1923, which describes Lemerrier as having more than 10 years of experience in that area.

The application of Camille Herrgott's fabric has not produced all the results expected from his work. In fact, his fabric has only been used to make blankets or heated mats, and during the war, he mainly made "overalls" for aviators.

1924 Le Correspondant: monthly magazine covering religion, philosophy, and politics.

In January 1919, drawing on his military experience, Georges Goisot published a 12-page catalog of flexible electrical heating devices. It includes heated mats for offices and lounges, beanbags, cushions, bed covers, compresses, belts, neck warmers, knee pads, gloves, slippers, etc. all heated by electricity. (January 4, 1919, General electricity review)



Electric heated clothes (1920 Sciences et voyages N° 26)



1919 G. Goisot heated gloves (Ultimheat catalog)



1919 Heating gloves proposed by Electric Equipment (Automobilia, the car for armies, October 15, 1919)



# Historical introduction

## 1918-1940 Extension of electro-domestic applications

The end of the 1<sup>st</sup> World War was marked by a shortage of coal, due to damage to French mines in the Nord/Pas de Calais region, and the rising price of imported coal. This benefited electric heater manufacturers. Georges Goisot's flexible appliances were soon imitated. At the fair of Lyon in March 1917, Parisian manufacturer L. Brienne had already presented heated mats and electric compresses (1917 Catalog of the Lyon Fair, Ultimheat Museum)



1920 L. Brienne, 350x350mm heated mat, 10 rue Allibert founded in 1890, Paris (Ultimheat catalog)

At the fair in Lyon in March 1919, at booth #8, group 10, the George Fox Electricity Heater factory exhibited its new devices for medical, industrial and domestic use, such as: Compresses, slippers, knee pads, blinkers and gloves, hidden or visible heaters and burners, soldering irons, workshop irons, household and travel irons, curling irons, bed heaters, foot warmers, kettles, stoves, cigarette lighters, heating mats, etc., as well as the well-received "Thermo-Fox" liquid heater. (General Electricity Review, March 15, 1919)

At the same fair, the "Company for the Manufacture of Electric Heaters and Domestic Appliances" (Calor), located at the time at 200 rue Boileau in Lyon, did not exhibit thermoplasme or heating blankets, but announced that it "manufactures all electrical appliances imported before the war." In October 1919, at the autumn fair, it announced sales of 300,000 appliances.

At the end of 1919, the Lemerrier Brothers Company was created, which developed "Thermaplasm", and launched an advertising campaign in Parisian newspapers. "In these restrictive times, electric thermoplasma with a safety regulator is necessary in any interior. For healthy people, it will replace bed heaters that go cold. For the sick or the weak, it will

replace smelly, inconvenient compresses and will protect against flu thanks to its reactive action" (Le Figaro, January 4, 1920, and the Petit Journal of the French Social Party, January 1).



Footmuffs, Electric Blankets, Thermaplasm (1922 Lemerrier)

For Camille Herrgott, the situation was becoming difficult; his 15-year-old patents fell into the public domain in 1916. During the war, while his uncle Henri Chaudel, head of the factory was called up, production at the Valdoie factory was devoted solely to the war industry (grenades, shells, mixing of smokeless powders, and fasteners). There was no room to develop heated blankets. On 9 September 1918, Henri Chaudel died in action. His son Edmond replaced him, assisted by Camille Hergott. At the end of the war, the activity of the plant was mainly devoted to the urgent production of major supplies for the drying of flooded mine shafts. Under pressure from strong competition, with reduced manufacturing possibilities, he abandoned heated blankets around 1921. The flexible medical heating fabrics and clothing, from Gaiffe-Gallot and Pilon in Paris, were abandoned around 1923.

In 1921-22, while sanatoriums were being developed, they brought a need for medical blankets that would allow patients to stay longer in the open air, which in turn led to an arrival of new manufacturers such as Victor Russenberger (making compresses, bed warmers, heating mats, and later known for his switches), Albert Bourgain (Fulgator Heating Mat), Fare, and Calor.



1921 Fulgator heating mat produced by Albert Bourgain



1921 range of flexible heating elements from Fare (Ultimheat Catalog)

Because of permanent improvement of our products, drawings, descriptions, features used on these data sheets are for guidance only and can be modified without prior advice





Because of permanent improvement of our products, drawings, descriptions, features used on these data sheets are for guidance only and can be modified without prior advice

“Little known before the war, the electric heating of clothing has grown considerably in recent years. It can now be said that in cars, it is no longer necessary to suffer from the cold, even on the longest of winter journeys. During the war, the air force needed effective protection against Siberian temperatures (-40° to -50°) for pilots navigating at high altitudes. As a result of this necessity, an industry was born which created and developed a series of devices that increase the comfort of an activity that many see only as a means of transport, whereas heating wire is a good conductor for the heating parts, inside of which it becomes very resistant, i.e. long and thin, which gives it all the flexibility necessary for use in clothes. Well insulated, and made of stainless metal with high-resistivity, this wire is only a few hundredths of a millimeter in diameter (10 to 11 hundredths), depending on its nature: nickel or nickel silver. It is several meters in length, thus creating many curves in the fabric. However, the fabric is not so specialized, and application is so easy that a factory can convert an ordinary blanket into a heating blanket in a few hours.” (L'Ouest Eclair, dated May 15, 1922)



1923 advertising for Calor thermoplastic

In 1922 Calor began to produce its Thermoplasm that was presented as follows: “The reason for the superiority of our fabric is that we have been able to weave our resistance threads directly onto the machine. This process allows us to introduce you to devices with undeniable advantages, that had remained unknown until now. The absence of asbestos and the impermeable insulation covering the “Calor” fabrics make them fully resistant to humidity. It is designed for all voltages from 12 to 220 volts without any increase in price. It cannot be used as a bed warmer”. (1923 Calor)

1925 Charles Mildé and sons (Heated carpets. Consumption: 30 Watts). We can deliver all heated blankets operating at any voltage. We manufacture blankets for apartments (operating at 110 volts), cars and aircraft (operating at 12 or 16 volts).

The technology developed for the thermoplasm gave rise to two other Calor products using flexible heating elements: the heated mat and the bottle warmer. (Catalog Calor 1926 Ultimheat Museum)

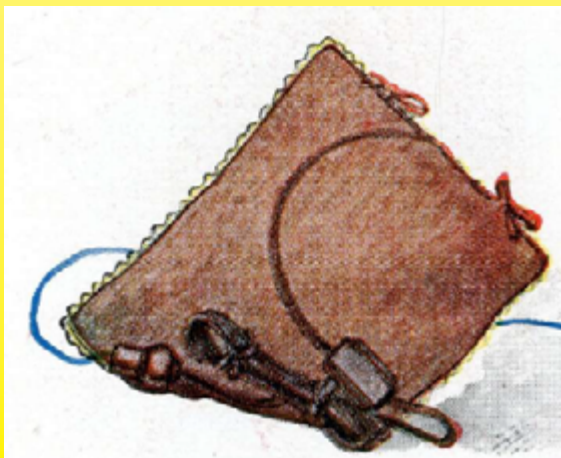

1926 Calor Thermoplasma with a switch on the cord (Catalog Calor 1926, Ultimheat Museum)



1926 Calor Heated Mat (Catalog Calor 1926, Ultimheat Museum)

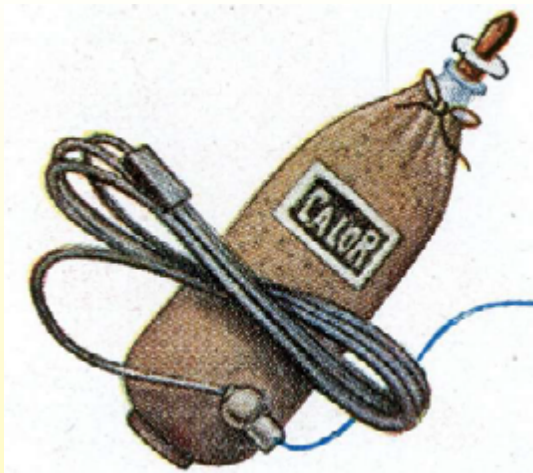

1926 Calor Flexible Bottle Warmer with Switch on Cord (Catalog Calor 1926, Ultimheat Museum)

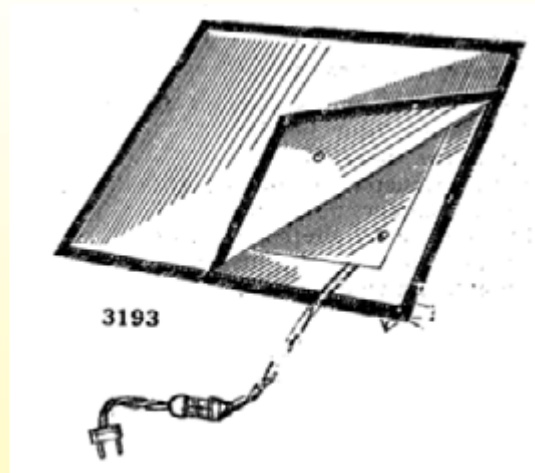

1930 Heated blanket, 120 x 80 cm, about 50W. It is very practical, and can be left connected for hours in a covered bed (Bazar d'électricité, G Cochet) The switch on the power cable is identical to the switches on the lighting cables

1930, USA, The first electric blanket is made available for sale by Samson United Corporation



In January 1929, Abkin, who had just patented a model of electric blanket, began manufacturing and distributing it. He would then present it for the first time at the Salon des Arts Ménagers in Paris in 1930, under the brand Perfecta. It is described as 'peerless' (Picture from 1931)

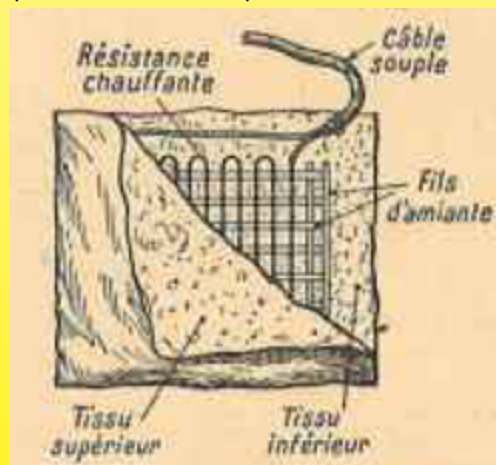

The following passage on personal heating is from 1932: Heated fabrics in the form of carpets, slippers, blankets, knitwear, jackets, ... where the heating resistance (50 watts) is insulated by two asbestos wires, woven between two layers of fabric (1932 Boll, Electricity to the City and Countryside)

.. 1932 Alsthom and La Cie Générale d'électricité propose thermoplasms; Lemercier thermaplasms and carpets.



Because of permanent improvement of our products, drawings, descriptions, features used on these data sheets are for guidance only and can be modified without prior advice



**Catoplasme en tissu souple léger,** avec une taie en flanelle lavable, monté avec régulateur de chaleur à 3 températures, livré avec fil souple.

N°	Dimensions en %	Consommation en watts.	Prix.
17787	18×25	20	81. »
17788	25×32	30	95. »
17789	30×40	40	108. »
17791	40×40	60	122. »

**Tapis chauffant moquette de 35×35 %.** Cet appareil de consommation analogue au chauffe-pied est mieux indiqué pour les appartements.  
Consommation 40/50 watts.  
N° 17799. Prix ..... 72. »





**COUVERTURES CHAUFFANTES ÉLECTRIQUES**

Modèles recommandés, ne demandant ni réglage ni entretien.

N° 17794 A. 120×80 % (110 à 250 volts). Prix ..... 390. »  
N° 17794 B. 80×60 % (110 à 250 volts). Prix ..... 290. »

*Tous nos modèles sont livrés, complètement équipés, avec câble de 2 mètres et prise de courant.*

Modèles pour usages médicaux, pour chaises longues, chirurgicales, avec limiteur de température, et types spéciaux :  
**Prix sur demande.**

1933 Bouchery displays electric poultice compresses, heated mats and electric blankets in its catalog **1939-1945:**

- Restrictions in use and production in France,
- Development in England and the USA

1939: World War II and the years that followed brought fuel restrictions and shortages, reviving interest in electric blankets, which were particularly economical in terms of electric power, as well as in all electric bed-warmer systems. However, due to lack of raw materials, particularly nickel and chrome, which were necessary materials for heating wires, production of electric blankets ceased. Furthermore, from June 6, 1943, the sale of electric heaters, blankets, bedheaters and thermoplasms was prohibited except with ration cards.

**ET<sup>S</sup> ROGER MARCHAND**

103 à 109, RUE OLIVIER-DE-SERRES - PARIS-XV<sup>e</sup>  
Téléphone : VAUGIRARD 21-80 — R. C. SEINE 446.755

---

**Appareils de Chauffage Electrique**



MARQUE DEPOSEE 215349

**Radiateurs paraboliques — Bouilloires  
Chauffe-lit à accumulation**

1941 Roger Marchand Storage Sleeper (Mastier, Domestic Electric Heating)

**CHAUFFAGE ÉLECTRIQUE**

*Toilectro*

**CLIN ET C<sup>IE</sup>**

USINE A CHARTRES  
56, rue de Revery. Tél. 13-02.  
DEPOT A PARIS  
14, avenue de la République  
Tél. : Roq. 50-45.

RADIATEURS obscurs et paraboliques  
BOUILLOIRES  
CAFETIÈRES  
CHAUFFE-LIT  
CHAUFFE-PIEDS  
TAPIS-CHAUFFANT  
FERS A REPASSER

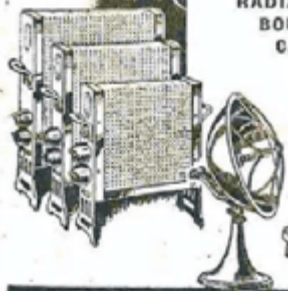
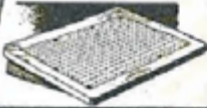
CUISINIÈRES  
RÉCHAUDS  
GRILLE-VIANDE  
R.C. Chartres

1941 Toilectro heated mats (Mastier, Domestic Electric Heating)

1941 (7 February), while supply restrictions were starting to be applied, Chaluvia Electrical Appliances, 33 rue Bergère in Paris, offered an "Ideal" electric bed heater and electric compress.

1942 The use of nickel for the manufacture of most heating elements is banned in France, forcing the metallurgical company Imphy to develop a new nickel-free resistive alloy: RCR



Conformément au vœu exprimé par l'Office de Répartition des Fers, Fontes et Aciers, l'impérieuse nécessité d'économiser le nickel a conduit les Aciéries d'IMPHY à mettre au point un alliage sans nickel répondant aux mêmes conditions d'emploi que le RNC.0 ou le RNC.00. Ce but a été atteint avec la nuance RCR que nous présentons dans cette notice. Cet alliage utilisable jusqu'à 600° se substitue au RNC.0 ou RNC.00 sans qu'il y ait lieu pratiquement de modifier les sections et les longueurs calculées pour ces alliages.

Document from Impy 1942, RCR alloy (Ultimheat Museum)

June 1943: Prohibition of sale. An order of June 5 (OJ of 9 June) declared it forbidden for companies to sell directly to the public, offer for sale, rent or exchange, bed heaters, foot warmers, heating pads (electric compresses), electric blankets, or heated mats, except with ration coupons.

Outside of France, research on electrically heated suits for fighter pilots during the war improved safety and allowed manufacturers to make thinner and easier-to-fold blankets. One in particular was American company General Electric, one of the largest manufacturers of electric blankets. In 1945, it started advertising its automatic blanket, highlighting the link with its wartime manufacture of "warm" suits for pilots fighting around Japan. French manufacturer Lemercier developed a heated "aviation" suit, which was standardized after the war, and so did its competitor Airaile.

**1945-1960. Post-war. Sales of electric blankets explode resulting from coal shortages. Arrival of safety thermostats and timers in heating blankets and compresses.**

In 1946, only a few manufacturers could restart production quickly: Airaile in Angers (blankets, compresses, military and civilian heating clothing), Calor in Lyon (thermoplasts), Suzor in Boulogne sur Seine, (thermoplasts, heating fabrics) and Verpillat (heated blankets) in Lyon.



1947 Suzor Thermoplasma. Heating compress with 3 heat levels controlled by 3 switch positions. Total safety by double thermostat, and padded interior ensuring very regulated heating power: 50 watts Dimensions: 250 X 320mm Available in 110 or 220 volts (Ultimheat catalog)

The Thermoplasma distributes beneficial heat by simply applying it on the diseased part. It replaces the old-fashioned, inconvenient and messy compress. It acts effectively against colds, bronchitis, pleurisy, flu, indigestion, etc...



## Historical introduction

It has an easily reachable and adjustable switch, which can be set at 3 different temperatures. Small notches make it possible to know the position of the switch with respect to the different heating levels, and to adjust them, even in the dark.

Automatic temperature regulators. Two automatically functioning temperature controllers ensure maximum safety in case the device is forgotten about while connected to the current. The "Calor Electric Thermoplasm" recommended by the Medical Corps has its place in the family pharmacy, as well as for necessary medical applications (Calor catalogue, 1947, Ultimheat Museum).



The 3-meter-long cord is equipped with a marbled Bakelite switch, which can be easily operated by the patient with one hand and provides three degrees of temperature and an off switch. Position 0: Off Position 1: Low Position 2: Medium. Position 3: strong.

Once the desired temperature is achieved, it will automatically remain constant. This is thanks to two thermostats or temperature regulators that instantly stop the current during excessive heat, and restore it as soon as the temperature returns to normal. (Thermor heating pad 1949)

In 1949, the manufacturer Angevinois Airaile, whose experience in heated fabrics and heated military clothing dates back more than 25 years, decided to open an office at 27 Avenue Mozart in Paris.

He exhibited heated blankets and thermoplasms from 50 to 180W at the Paris fair in 1949, and in Metz the same year (where he received a major prize),

These products use "compound" aviation type heating cords composed of multiple self-regulating pure nickel fibers, coiled on a textile core with high mechanical strength and insulated by overguiding. They are equipped with precision thermostats that automatically limit heating, even if the user forgets that they are connected. Particularly advanced compared to its competitors, these thermostats were accelerated by additional resistance. Power is set with a rotary switch with three contact positions and two bipolar cutoffs.

It also offers a 40-watt heating vest, which is a sort of sleeveless bib.

They are quite wide, made of strong cotton canvas, and are available in different voltages from 6 to 220V, for rural, agricultural and industrial applications (various Air-Aile catalogs from 1949, and Ultimheat catalogs from 1951.)

Between 1950 and 1960 in a booming market, the competition became fierce between many manufacturers of heated blankets and thermoplasms. Here is a non-exhaustive list of them:

**Abkin (A.)**, 95, boulevard Soult, Paris 12th. (Perfecta brand)

**AEM.**, 5, rue de la Procession, Paris.

**AirAile**, 1 bis, rue J.-P.-Timbaud, Issy-les-Moulineaux (Seine).

**Amplelec**, ( marque Morphée)

**Area (A.)** Grand-Gallargues (Gard).

**Armand (M.)**, Digne (B.-A.).

**Astoria**, 26, r. St-Charles, Schiltigheim (Bas-Rhin).

**Baugas et Cie**, Chemillé (M.-et-L.)

**Barrière (A.)**, 282 boulevard Voltaire, Paris 11ème. Latest product: The latest electric blanket is made of silicone glass fabric (Tentation brand)

**Bois (M.)**, 2, rue Condorcet, Cachan (Seine).

**Botteau**, 37, rue Cambronne, Paris.

**Buga (Ets)**, Obernai (Bas-Rhin).

**Calor**, place A. Courtois, Lyon.

**Camulco**

**Chromex**, (1953)15 rue du Port, Le Mans (Sarthe).

**Coillard (R.)**, pl. de la République, Cours (Rhône).

**Constellation**, 16 ter, rue Censier, Paris.

**Covex**

**C.R.E.O.** rue de la Barillerie, Le Mans (Sarthe).

**Degois (Jean), (then Raymond Degois)** Jidé brand (1949 ca, 1962) The heating cord makes it possible to make a heating blanket very easily without electrical knowledge. The net bed warmer, very light, compact and easily



transportable. Unbreakable resistor, spiral curled by patented process. The heated blanket. Comfortable. High quality wool. Guaranteed security. The creator of the electric blanket resistor, 66, Rue Francois-Chénieux Limoges (Hte Vienne)

**Despont**, 276, rue de Belleville, Paris.

**Elefo**, Obernai (Bas-Rhin).

**Eletex**, 27, r. Ferrandière, Lyon.

**Euphorie**, (1950, 1955) 71 rue Hippolyte-Kahn, Lyon-Villeurbanne. The Euphorie workshops released 25,000 heated blankets this season, with more than 20 years of experience).

**Fox**, 64, bd de Ménilmontant, Paris. (Thermoplasms only).

**Gautier (A.)**, 7, rue de la Mignonne, St-Rambert (Rhône).

**Petit (G.)**, (Gelux brand), 6, Place Léon Deubel, Paris 16th (with 80-20 Chrome Nickel resistance).

**Gervaiseau**, 151, av. Georges-Durand, Le Mans. (Thermoplasms only), bimetallic thermostat patent in March 1957 (Evo-Stop).

**Guérillot (Pierre)**, (Filecho electronics brand) Safety electric bed-warmer, Heating mat for cars and trucks, Antifreeze heating radiator for pipes, Heating cushions and thermoplasms, Floor heating (Chassis), Heating vests for motorcycles and tractors.

Pierre Guerillot filed a patent in 1951 for a flexible heating fabric composed of two PVC sheets with a sheet of bare heating threads incorporated between them. This was the predecessor to the future flexible industrial fabrics made of silicone. 305 rue de Belleville, Paris 19th.

**Hawai**, 16, rue Léopold-Bellan, Paris.

**Hudson France**, 29, rue de l'Hôtel-de-Ville, Lyon.

**Hornung**, 12, quai St-Nicolas, Strasbourg (thermoplasms only)

**Hydro-Electrique A.M.C.**, Arpajon sur Cère (Cantal).

**Irga**, 5, rue du Parchemin, Strasbourg.

**Jema** Fully removable heating blanket, with a thermostatic regulator that makes the product very safe. Beautiful Merino, all colors (180 x 120 and 140x120), 46 rue de Paradis, Paris 10th

**Jost (J.)**, Beblenheim (Ht-Rhin). Thermoplastics only

**Kalliste**, Covers with self-regulating resistances

**Lampargent**, 25, rue Claude-Terrasse, Paris.

**Manufacture de tissus thermiques** 1, rue Girard, Vienne (Isère).

**Menneret (PA)**, wholesale distributors, Andalouse brand, 38 Chapeau Rouge, Bordeaux

**Philibert et Maury**, 14 rue Bèchevelin, Lyon.

**Floor (Ateliers P.)**, 93 rue Oberkampf, Paris 11th. Company founded in 1900, resistant cords for heating blankets and cushions

**Rachline (Ets)**, 39, boulevard Ornano, St-Denis (Seine) (Heating mattresses)

**Radialaine**, Le Mans

**Central Electric Heaters**, St-Pourçain-sur-Sioule (Allier).

**Raveleau (A.)**, La Grange-St-Pierre, Poitiers. (Equator brand)

**Rhoneclair**, (1954) rue de Chauffailles, Cours (Rhône).

**Rossi-Paret**, 49, rue Victor-Hugo, Vienne (Isère).

**Seecta**, 3, rue Royet, Caluire (Rhône).

**Sibéria** wool and cotton heating blankets with 3 heat settings (Lower Alps)

**Solis France** (1955 ca), 12 rue Guillaume Tell, Mulhouse.

**Thermel**, 33, rue du Hochât, Châteauroux. (California Brand)

**Thermodor**, 12, rue Victor-Bonhomme, Le Mans

**Tisselec**, 66 avenue Felix Faure, Lyon.

**Treselle (Fernand.)**, Mark Ellesert Securematic. With thermostats and 3 settings; 12, rue Godefroy St-Hilaire, Lille.

**Electro-Rivoli**, (Vedette brand) 1, rue de l'Ysere Grenoble, then around 1961, 19 rue de l'Ordre, Lyon 3rd.



In 1955 Calor began manufacturing thermostatic blankets under US licensing. Its temperature is adjustable, and its new thermostats fully prevent overheating. (1955 advertising Calor Collection Ultimheat)

One of the criticisms of the heating blankets of that time was that the user might fall asleep, leaving their blanket on the maximum power setting, which could cause burns in certain cases. The years 1956-1957 would therefore see different devices appearing, incorporating functions to automatically stop heating after a certain period.



## Historical introduction

Because of permanent improvement of our products, drawings, descriptions, features used on these data sheets are for guidance only and can be modified without prior advice



In 1957, Jidé unveiled the “Jidéstop,” a timer that automatically switched off heated blankets. Coupatan then put an equivalent product on the market, and Calor released its “Tempomatic”. Chromex followed in 1958 with its “Stop Index”. Also in 1958, Jidé changed its timer to have two stages of heating, with the blanket automatically switching to lower power after a certain amount of time (Patent 1.198174).

On January 1, 1957, the USE-APEL quality marking was introduced by the Technical Union of Electricity, for electric blankets. This was necessary due to the dangerous products produced in the immediate post-war period, and the numerous accidents which resulted from them.

The old NFC 6023 standard, which covered blankets and thermoplasms (which contained only simple and limited technical requirements such as wire crossover, resistance to bending, heat and moisture, and a single thermostat) was replaced by standards NF C 73-147 (for heated blankets) and NF C 73-123 (for thermo-plasms).

Vedette and Kalliste were the first manufacturers to obtain the USE-APEL mark.

These new standards created two categories based on the type of heating element:

- covers whose wire or heating element is attached to a support fabric using seams, or any other equivalent process. This category was designated by the letter T.

- covers whose wire or heating element cannot be removed. This category was designated by the letter N.

Also, two classes were created depending on the voltage:

- blankets that connect directly to a 110 or 220V distribution network.

- blankets intended to be powered with very low voltage. “ (Equipment ménager 1961).

A temperature regulator became mandatory for thermoplasms, and at least two regulators were required for blankets, which were now subject to more than 15 different tests to check their operational safety.



1959 Calor launches its Textomatic Warming Blanket, featuring a continuous temperature control system with an energy meter. It added the “Tempomatic” option, an automatic shut-off timer, to its simple blankets

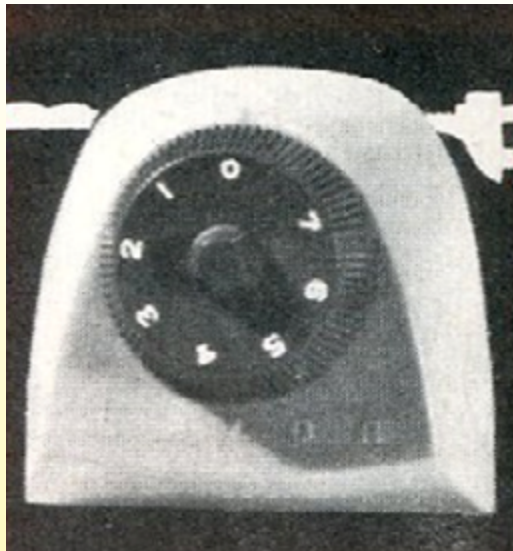

1960 Calor Tempomatic (Ultimateat catalog)

1980 Chromex offers all its heated blankets in water resistant versions and with the NF "Flame Resistant" label.

## Mattress heaters

1957 We are beginning to find systems on the market that are placed under the user and not on top of them. These items must be equipped with a fastener system and be rigid enough not to fray and fold on themselves. The heated cover for the Grizzli mattress is made up of an integrated resistor between two layers of fabric. The lower fabric serves as a support for the resistor that is fixed by a patented weaving process. The upper fabric is glued (gutté) on top, by another patented process. The resistor is multi-stranded made from chrome nickel coated in a special heat-resistant plastic. This is a new modern process that allows the product to be washed, and therefore, it also works in water.

It has two heat settings, and an extension with a switch. Its thermostat is waterproof and fully insulated.

(1957 Thermal fabrics factory, Ultimheat Museum)

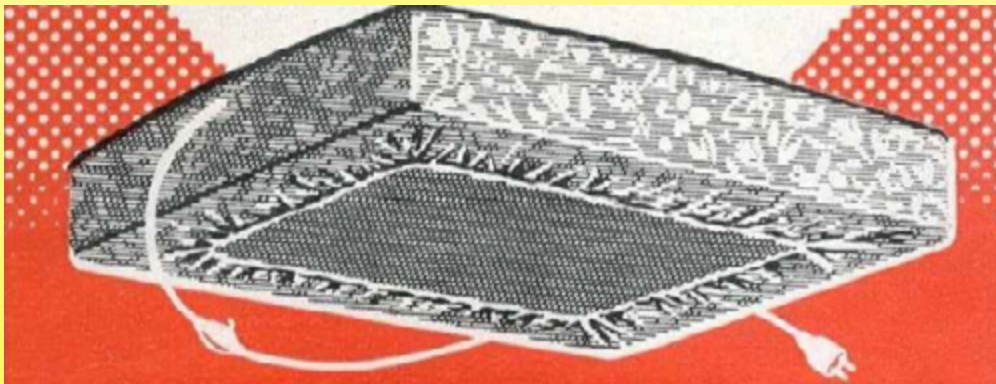

Grizzli heated blanket (1957 Manufacture of thermal fabrics, Ultimheat Museum)

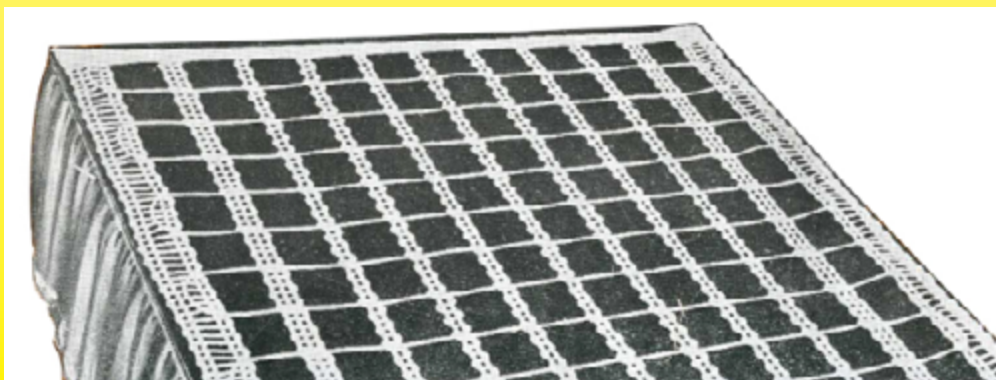

Jidé bed warmer (1957) Its heating cords were covered with two layers of cotton: Guipe and braid) and plastic cladding. (Jidé Catalog 1957, Ultimheat Museum)





## Historical introduction

### Silicone insulation

The flexible heating cords at the time lacked a varnish to make them watertight. The cords were then coated with textile insulation (cotton, wool etc..) but there was no varnish flexible enough to make them waterproof. In 1939, PVC began to replace rubber as insulation for domestic electrical cables. In 1949, while PVC production was still in its infancy in France, Sarl Lyon Tisselec, led by Maurice-Pierre Marchal, added a flexible PVC and polyethylene type varnish around the heating cords. This solution guaranteed a certain resistance to moisture and good flexibility. However, the temperature resistance of the PVC was insufficient to be used on a wire charged to 7W/m.

Invented by Dow Corning in the US shortly before the Second World War, and made public in 1944, silicone rubber was initially reserved for military applications. Rhône Poulenc began experimentally producing silicone (Rhodorsil) in Lyon in 1948, and then opened its Saint Fons factory near Lyon in 1954. This elastomer was first used to impregnate braided fiberglass sleeving, allowing small electric motors to operate at a higher temperature. This glass silk withstood heat very well. Its silicone impregnation gave it good impermeability and resistance to many chemical agents. (1954 Meci, Ultimheat catalog)

As early as 1954, silicone-impregnated glass braid insulation was manufactured by Silisol.

-Shortly after, when rapid vulcanization mixtures were developed for direct extrusion on electrical conductors, silicone heating wires started to appear. Vulcanized silicone combines extreme flexibility with excellent temperature resistance (up to 200-250°C), and good electrical insulation allows it to make heating wires that are particularly suitable for blankets and flexible heating elements. This technique replaced neoprene insulation that had just started appearing in heated blankets and flexible heating elements.

In 1958, although costly, silicone insulated heating cables were widely used in the USA for defrosting refrigerators, removing snow, and other similar applications. This is because silicone is resistant to the high temperature of the heating core, resistant to cold, and has excellent sealing qualities. However, its lack of mechanical strength forced manufacturers to develop cables covered with a flexible metal braid for some applications. This turned out to be the origin of industrial electrical tracing.

Even before 1959, the company Electrofil in Joinville proposed isolated resistive silicone wires (Silastic). At the time, the heating cables of blankets were all made by winding small diameter heating wires onto a cotton core, and this did not withstand the very high temperature necessary for the continuous vulcanization of the silicone. The replacement of this cotton core with a glass filament core allowed this manufacturing to take place. This technique is still used today.

In 1960, a new technical solution appeared - the use of uninsulated heating wires, sandwiched between sheets of silicone elastomers and reinforced with glass fibers, and then vulcanized. The assembly then formed a waterproof sheet. The manufacturer Méneret wrote at the time: "All our heating blankets are equipped with special resistors insulated under totally invisible channels."



1965 Thomson heating blankets with insulated glass filament resistors and self-regulating heating wires on a glass filament core

This technique would be (and still is) widely used in the industry for reheating drums by heating belts, but also in a host of applications in which reheating of a flat or bent surface is required. In these industrial applications, the use of silicone made it possible to reach surface loads of up to 2W/cm<sup>2</sup>

As early as 1961, the silicone insulation of heating elements for electric blankets and other flexible appliances became a clear technical solution. Some manufacturers began to use it, such as Tissélec, which offered 2-circuit inserts with silicone rubber inserts, and 2 thermostats (this company equipped them with an extrusion line made from silicone insulated heating wire), and Treselle, with its blanket that had a self-regulating resistor, a silicone core and silicone insulation. In 1965 Thomson followed suit and equipped their heating blankets with self-regulating wires with silicone insulation.

In 1970, Calor commercially released heating blankets using "its new electrical circuit with an ultra-flexible silicone insulating sheath, bringing great robustness to the heating element"

Resistelec-Tisselec, which manufactured this type of flexible resistor, was bought out in 1973 by its supplier Driver Harris (American manufacturer of nickel and nickel alloy resistive wires), and then in 1984 by Flexelec,

a company created 2 years earlier. Shortly after this takeover, Flexelec ended production of insulated silicone heating wires.

## Cables and heating cords. First applications in horticulture and the early stages of antifreeze heat tracing

Around 1925, a Norwegian engineer named C. Jacobsen noticed that the snow had melted and that the vegetation was clearly visible all along underground power lines. From there came the idea of using heating wires to increase the growth rate of crops. Thus, this branch of heating was born, which progressed rapidly because of its numerous technical and economic advantages, and which quickly attracted German, Dutch and French horticulturists.

From the beginning of 1929, experiments on electrically heating the soil for vegetable production were carried out at the Fontaines School of Agriculture in Saone et Loire (Ruling by the general council of Saone et Loire, August 1929)

In Holland, the first heated cables for horticultural use were installed as an experiment during the winter of 1929-1930 in The Hague, Delft and Rotterdam. They had been produced by the Swedish company Sievert de Sundyberg. They consisted of a 0.73mm diameter resistor wire, with a linear resistance of 1.10 ohm per current meter. Two coils of asbestos helically wound in the opposite direction, then a layer of impregnated paper, and finally a 1.3mm thick lead sheath, ensured the insulation and mechanical protection of the resistor wires. The outer diameter of this heating cable was 4.7mm. The lead sheath, with a linear resistance of 0.13 ohm, also acted as a return current conductor. For this purpose, the free end of the cable was welded to the resistor wire. Each 50m long cable, can be charged up to 5 A or 22W/m (1931 BIP Information and Electricity propaganda N 37)

In countries with a harsh climate, such as the Scandinavian countries and Germany, heated cables buried at 30 centimeters maintained the temperature of greenhouse layers. The current at night could be set to a very low rate, and the savings in heating costs are estimated to be around at 75% (Le Temps, April 27, 1932)

**1936** To speed up the growth of early vegetables, horticulturists are making use of layers of crops covered with glass. Successful experiments with electrically heated layers was well received in various regions of France and abroad. For this purpose, controlled trials were carried out in Nice from February 1 to 15 May 1935. The heating cable consisted of a cable reinforced with a nickeline conductor, and was 12/10mm in diameter. The power input was about 3 kW, or about 200 watts per square meter of land area. [NB: Nickeline was an alloy of copper, zinc and nickel, similar to nickel silver, and manufactured by the German company Obermaier] (1936 BIP No. 93, Ultimheat Museum)

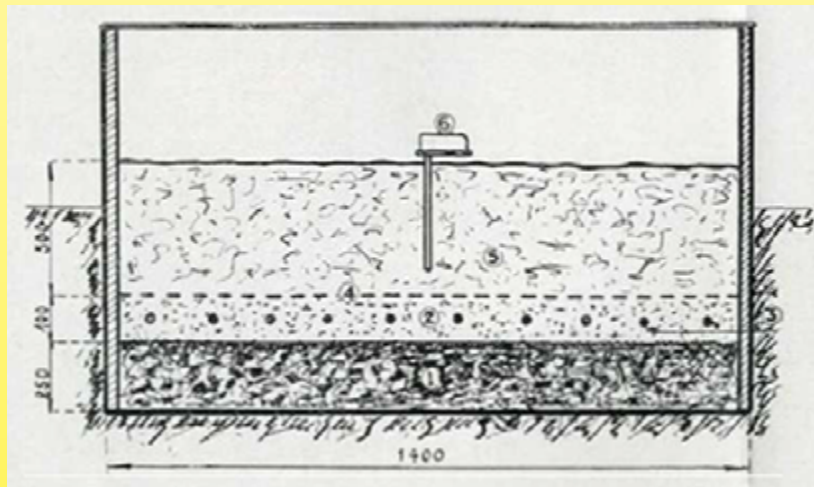

1: slag, 2: sand, 3: heated cable, 4 meshing, 5: potting soil 6: temperature limiter (1936 BIP # 93, Ultimheat Museum)

Horticultural applications using electric layer heating developed rapidly in France, and this type of heating cable was quickly standardized with two main French suppliers: Câbles de Lyon and Alsthom, using a straight heating wire. There was also a Dutch supplier, the Hollandse Draad in Kabelfabriek (Draka) from Amsterdam, that used spiral heating wire around an asbestos core.

Heating cables were a very special solution to the problem of heated parts, and they have since been widely adopted in the agricultural field for heating crops. However, these cables can be used industrially for relatively low voltages and low temperatures (up to 80°C on the cable surface), particularly in order to spread the heat as evenly as possible. There are currently three types of heating cables, which are listed below in alphabetical order:  
- A / Starting from the center to the periphery, the Alsthom cable comprises a resistant nickel-chromium wire with two impregnated cotton pads, a triple asbestos braid, a wrap of impregnated paper, pure lead casing and, in some cases, an additional sheath or strip of striated electrolytic zinc was added to avoid electrolysis resulting



## Historical introduction

from stray currents. The diameter of the bare lead cable is approximately 6mm and the resistivity may vary from 0.5 to 2 ohms per meter (in general, an amount equal to 1 ohm per meter is chosen). The maximum specific power is 30 W per meter or about 33 m.

- B / The Câblerie de Lyon cable was made of a resistant wire insulated by layers of asbestos and tar paper and wrung out. The whole system was coated in a lead sheath and protected against chemical corrosion by special treatment (sulphurization), and then covered with impregnated paper and strapping armor. The specific power varies from 25 to 40 W/m in general.

- C / The Draka cable (produced in Holland) is normally comprised of a nickel-chromium wire rolled on an asbest core (product made from asbestos) and surrounded by a mixture (of which we do not know the composition), which forms the electrical insulator and thermal conductor. The whole system is covered with a layer of pure lead. In some cases the cable is armed, the lead casing is asphalted, wrapped in impregnated paper, and then reinforced with 2 layers of strips, asphalted again and finally wrapped with impregnated paper. The outside diameter of the unarmed lead wire is 4.15 to 6.5mm. The specific power is usually 30 W/m.

Heating cables have three interesting advantages in particular: ease of use; resistance to certain chemical agents (pure lead sheath); low price (for example, a 1kW cable is currently worth about half the price of a magnesia-coated tube with the same power).

(1938 Protected Elements, Gautheret, Ultimheat Museum)

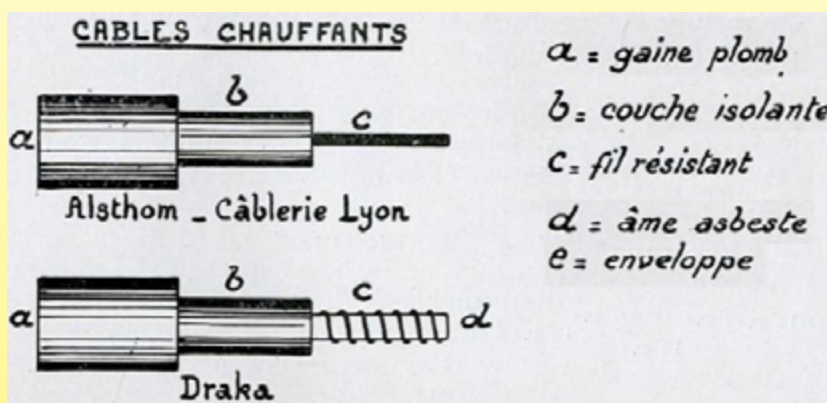

Alsthom heating cables, Câblerie de Lyon, Draka (1938 protected elements, Gautheret, Ultimheat Museum)

1938 The heating cable is deemed the heating device that best meets the needs of horticulture. It consists of a high-resistance alloy conductor (nickeline, nichrome, nickel, constantan), insulated with several layers of asbestos and impregnated paper, and mechanically protected by a lead sheath covered with an anti-corrosive coating, and sometimes double coated with a steel strip. The metric resistance of the cable to be installed depends on the length needed to obtain an equal distribution of the desired heat on a given surface.

Manufacturers are building cable types of various strengths, ranging from 0.15 to 2.55 ohms/m, to meet all needs

(1938 modern technology, electrical horticulture applications).

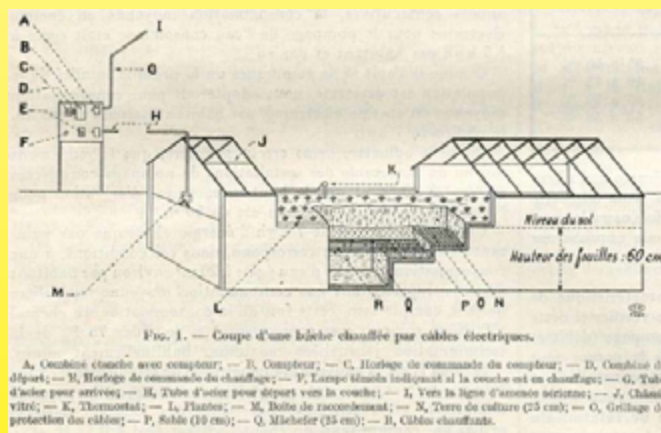

Horticultural plant heated with electricity (1938 modern technique, electrical heating applications for horticulture.)

In 1956, 2,500 French farms were equipped with it, with a total installed power of about 5000kW, and an annual consumption (exclusively at night) of 3 to 4 million kWh.

(Heating using buried flexible cables. 1956 Electric horticulture heating (Ultimheat Museum))



In 1957, the EDF manual describes electric heating applications in horticulture. Recommended values range from 150 to 200 W/m<sup>2</sup> for outdoor awnings and 80 to 120 W/m<sup>2</sup> for greenhouse shelves.

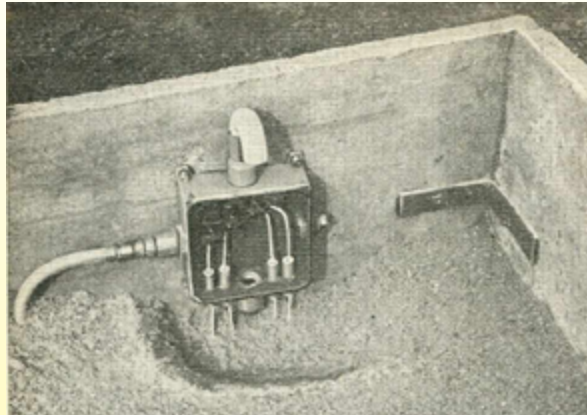

Electric heating of the ground, with the arrival of heating cables  
(1957, EDF Manual, Ultimheat Museum)

## Various applications of heating cables

The appearance in 1929-1930 and the development of heating cables for horticultural use gave rise to other applications. Waterproof and Coated with a mechanical protective lead casing, they could easily be used on their own. It was no longer necessary to have them integrated into an envelope like the heating wires of fabrics and small household equipment. The lead shield kept the cable flexible while providing some temperature resistance. Insulator technology evolved to have a higher temperature resistance and that gradually increased the range of applications.

As early as 1938, some industrial achievements had already been made with some of these heating cables, such as drying ovens for glazed wire, heated water pipes to prevent freezing, tanks for photographic solutions, and paraffin tanks. These cables were then used in low-temperature heating for liquids and air, such as in drying ovens, chamber-ovens, walls and heated floors

(1938 Protected Elements, Gautheret)

In 1946, the E Clin Company in Chartes (Toilectro) filed a patent (FR928369) for heating cardboard for ceilings and heating panels. It seems that no production followed this patent.

This heated ceiling concept led to several experiments. It seems that the first one took place in 1950 in Basel, where a store was equipped with a ceiling made with 14.4 kW heating cables drawn in copper tubes, placed 12cm apart, and embedded in the ceiling plaster. The ceiling temperature did not exceed 45°C.

(ASE Bulletin, 2 September 1950, 1951 BIP N 153 Arts ménagers)

1963 saw the first French example of domestic heating: a heating cable embedded in the floor. It was presented at the international construction exhibition by the company Panélaç. It worked by thermal accumulation during "off-peak hours" (1963 Domestic equipment N92, Ultimheat Museum)

In 1966, as with heat blankets, silicone modified the design of flexible industrial heating cables and fabrics. On the market, we began to find heating cables consisting of a single or double Fe-Ni-Cr or nickel-silver resistor wire, electrically protected by sheaths or braids of glass wool, or glass wool and silicone rubber.

For industrial applications (drying ovens, liquid heating) and agricultural heat tracing, these heating cables were mechanically protected by flexible sheathing made from either lead, steel or copper. Their diameter ranged from 4 to 9mm, for a linear resistance of 0.25 to 100 Ω per meter, and a general power of 30 to 40 W/m.

(1966 Electric Heating elements, Ultimheat Museum)

The development of self-regulating polyethylene-carbon cables in the late 1960s opened a new path for the electric heat tracing market, after their initial applications in domestic warming blankets stagnated.

A few years later in 1975, tests for pavement heating with heating cables were tested in the Cher region (Official Journal of 14 January 1976)

Flexible heating cords, with PVC, silicone, PTFE or polyolefin insulation, using resistive or self-regulating metal conductors, became an important new branch of electric heating, with new opportunities opening up as new products emerged. Examples included heating cords for refrigerated windows, heat tracing heated cables, pipe anti-freeze systems, road de-icing, roof snow removal, frost protection for meters, and domestic electric floor heating.



## Historical introduction

### Glass filament and high-temperature flexible heating elements, with fiberglass insulation for high temperature applications.

The appearance of a new insulating "textile" material that could be woven - glass filament, revolutionized the manufacture of flexible heating elements. Invented and first produced in the USA by Owens Corning in 1937, it appeared in France in 1938. But it was only around 1952-1954 that this fiber was produced industrially under license in France. This flexible fiber, (also called glass silk because the diameter of the filaments was similar to that of silk), is formed from molten glass at 1300°C. It is then extruded and stretched into filaments (strands) with an average diameter between 5 to 9 microns combined into single threads of 100 to 600 filaments. These single wires are then grouped and "twisted" to form cords that make up the core of the flexible heating elements, or the wrapping of the electrical wires.

Glass filament was an excellent electrical insulator, and was non-flammable and resistant to high temperatures. It was also braided and woven and as soon as it appeared, it was used for the production of sheets and fabrics. In short cut form, it was used to reinforce molded plastics. As early as 1948, glass fabrics were used by Tentation in the manufacture of electric blankets, just as some American manufacturers were already doing. It also rapidly replaced many asbestos applications, including the conductor core around which the conductor wires of the heating cords were spiraled.



Bundles of glass filament strands forming a single wire (Manufacture of glass filament, around 1960, lesson from the textile school of Verviers in Belgium, Ultimheat Museum)



1948 prospectus of the Tentation brand, produced by the Barrière Company (Ultimheat Museum)

Around 1960, high-temperature flexible heating elements, containing a nickel-chromium or nickel resistor enclosed in glass fabric, were introduced onto the French market. This technique allowed a maximum temperature of 550°C.

In this way, ribbons or bands were then produced, as well as simple fabrics of various shapes which could be made to fit any surface by assembling the simple fabrics in the required fashion.

Because of their flexibility and temperature resistance, they were used for heating autoclaves, tanks, ponds, tubes, pipes and laboratory equipment (Fig. 2 1).

Significantly more powerful than household electric blanket cords, some bands could provide a surface power of 0.4 up to 1.25 W/cm<sup>2</sup>.

By replacing the glass with quartz, it was possible to reach 800°C (1966 Heating elements, Ultimheat Museum)

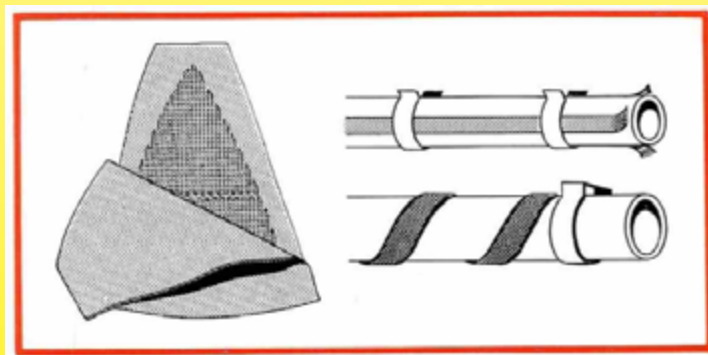

Fabrics and flexible heating fabrics made of glass cloth (1966 Electric Heating elements, Ultimheat Museum)

Shortly before 1966, industrial heating elements made of a graphite deposit on glass fabric started to appear on the market. The resistor consisted of a mesh network of extremely fine bundles of glass fibers, and a network covered with a layer of colloidal graphite with regular thickness. The resulting fabric was flexible and its electrical resistance could be adjusted according to the thickness of the deposit. The maximum allowable temperature was approximately 220°C, and regarding the carbon fiber heating elements which subsequently appeared, the temperature coefficient was slightly negative.

One of the longstanding applications of these fiberglass fabrics and chrome nickel heating wires was the laboratory flask heater. It was then knitted, often by hand in order to produce semi-circular heating elements.



### 1913-1980 High temperature asbestos-woven heated fabrics

At the end of 1913, the company E. Clin et Compagnie was founded in Paris. Its activity was based on weaving flexible heating elements with an asbestos and weft chain made of resistant heating wire. This was a technology similar to that of Camille Hergott. However, it was intended more for use with high temperatures. For this purpose it used looms for making trimmings. Most of the heating fabrics developed under the brand Toilectro were used in rigid electrical appliances requiring high temperatures such as radiators, toasters, and stoves. As they were easy to bend, they were also used in devices such as coffee makers and accumulation bed heaters to cover around tanks for heating liquids.

These heating fabrics were formed by a frame made from constantan or nickel-chromium, and a chain of asbestos wire. The wires were spaced as in a sieve that created ventilation and so produced excellent thermal efficiency. A canvas stretched vertically in the open air reached a temperature of about 100°C, for a consumption of 0.4 watts per cm<sup>2</sup> and 250°C for 2 watts per cm<sup>2</sup>. At 3W/cm<sup>2</sup> the wires would redden and destroy the asbestos. In 1921, Clin patented heating fabrics in which the canvas, insulated between slats of mica, was mounted in a metal frame. This formed a rigid system which allowed a maximum output of 5 watts per cm<sup>2</sup>. (Information from the Toilectro catalog, 1939)

Clin also produced a range of semi-flexible heating mats, with a lower surface power of 0.04W/cm<sup>2</sup> (50W for 35cms x 35cms).

The manufacture of these resistors, widely used in household electric radiators and convectors, continued without technical modifications until the years 1980-85. In addition to its low cost, this resistance was particularly quiet, with no dilation noise. The main manufacturers were Clin (Toilectro), La Toile Electronique, Noirot and Thomson.



E. Clin and Cie advertisement in the General Electricity Review, 1922

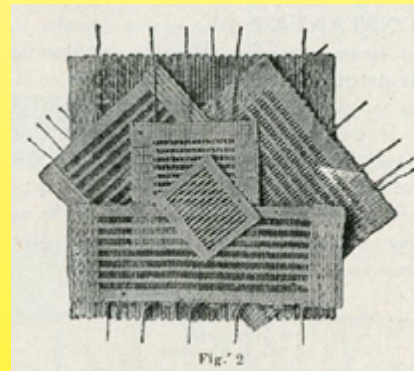

Toilectro asbestos heating fabric (catalog 1931). In May 12, 1921, E. Clin made a patent for electric canvas with reinforcement by mica plates (577486)

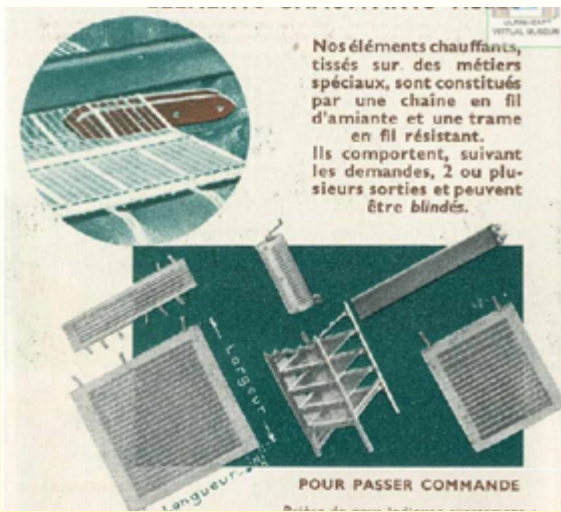

1939 Asbestos-woven elements (Noirot Catalog 1939, Ultimheat Museum)



Unarmed heating cables with asbestos core, for industrial applications (Noirot Catalog 1939, Ultimheat Museum)

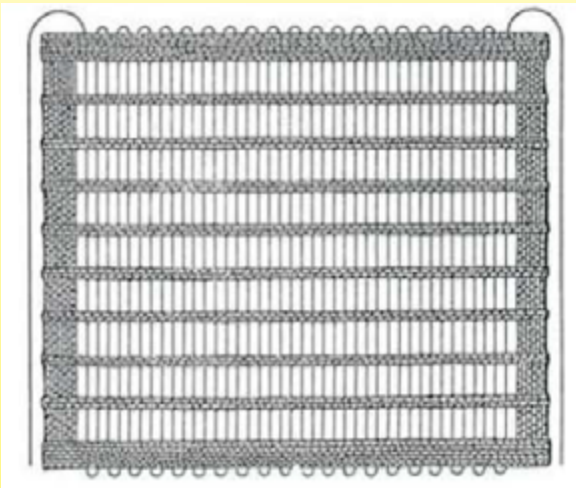

Heating fabric with asbestos chain, usable up to 450°C (1950 Ohmewatt)



Asbestos Heating Fabric (1960 Toile-électronique, Ultimheat Museum)

“Asbestos has great flexibility, good vibration resistance and is not brittle. A mixture (commercial grade) of 85% asbestos and 15% textile (cotton, fibran) is often used with a maximum temperature of 250°C. There are also two other qualities conducive to higher temperatures (450 and 800°C). In a practical sense, asbestos is used mainly for temperatures which do not exceed 450°C, or 600°C in exceptional circumstances, if used on the item. Asbestos is mainly used in the form of canvas, with the chain forming the insulation and the frame forming the electric heating part.

The chain is made up of a large number of fine asbestos threads. The warp threads are spaced according to the desired application. The makeup of the frame varies greatly, depending on its dimensions and the desired application. The following metals are most often used: nickel chromium, constantan, and nickel alloys, most often in the form of wires, and sometimes ribbons or cords. The section of the wires is small, for example from 0.10 to 1.30mm. When the conductor must be in the upper section, the wires are grouped parallel to one another. The frame arrangement can be very different, depending on the intended use of the element. For example, it could be a single circuit comprising a single wire or several wires grouped in parallel, with the conductors being regularly spaced (or not), multiple circuits, which supply three-phase or two-phase power, or a possible grouping in series or in parallel, etc. These canvases have an asbestos wire border that is thicker than the chain, and often of lesser quality. In the manufacture of fabrics, the only limit is the size of the loom, the width of its frame, usually 20 to 800mm. The elements delivered are relatively small in surface for mechanical and practical reasons (spare parts), with regards to the possibilities of the weaving looms (exceptional maximum of 1 m<sup>2</sup>). Asbestos has low electrical insulation, so the canvases are usually attached to their supports by soapstone or porcelain barrels, mica slices, etc. In some cases, they support the resistors and are themselves held in place by a metal frame. Another important application is that of heating cords, consisting of a calibrated asbestos bead on which the metal conductor is wound and covered (or not) with asbestos braiding or other insulating substances”. (1966 Electric Heating elements, Ultimheat Museum)

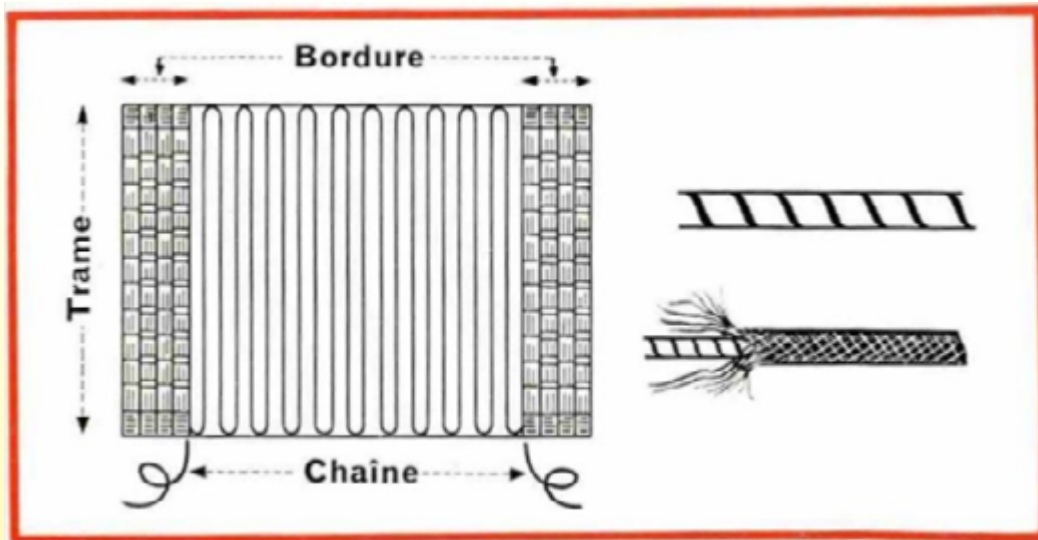

Asbestos heating fabric, and asbestos heating cord and braid (Electric heating elements, 1966, Ultimheat Museum)

In August 1977, awareness of the danger of asbestos led to a first decree on the protection of workers exposed to asbestos dust, followed by a total ban of asbestos in France in 1997. As a result, these types of heating elements disappeared from the market.

## Plasticized fabrics and heating ribbons

Developed in 1940 with rubber insulation, these flexible fabrics were quickly put to use for de-icing aircraft wings.

In the early 1960s, following the development of PVC and silicone elastomers, the first flexible heating elements for industrial use appeared in the form of ribbons and plates. Most of its insulation was made by a polymerized or vulcanized elastomer resin around a heating wire. The elastomers used were PVC, silicone, and sometimes neoprene.

There were also woven canvases, which were made with a sheet with an asbestos chain and a Ni-Cr or constantan frame, embedded in a silicone gel. These flexible blocks were manufactured 2.5 to 5mm thick, in rectangular format (up to 0.90 x 0.20 m) or square format (up to 0.50 x 0.50 m), with variable power densities, from 0.4 to 1 W/cm<sup>2</sup>. Their maximum temperature was 250°C.

Over the years, their technology evolved, and they were made using two strips of fiberglass-reinforced silicone, vulcanized together by sandwiching a sheet of heating wires.

This technique is now widely used industrially for heating flat surfaces, cylindrical drums and heating drums.

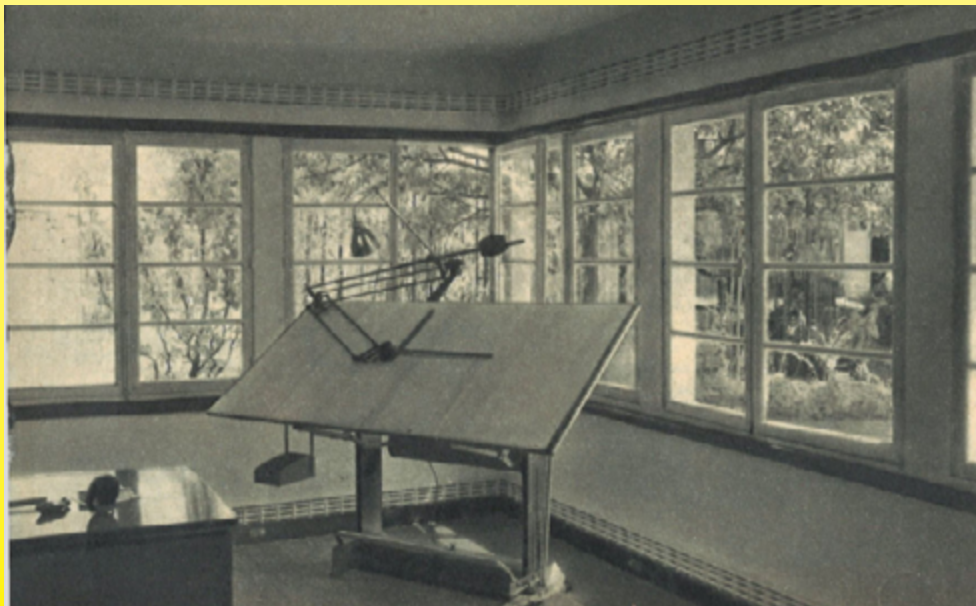

Rubancalor heating tape, manufactured by RAS, girdles not only the ceilings but also the wall bases (1958 Rambert, Le chauffage, Ultimheat Museum)





## Historical introduction

During the same period, heating strips were also formed consisting of parallel conductors, embedded in a polyvinyl strap, constituting a 13mm wide ribbon, and allowing a specific power of 20-25 W/m up to 100°C.  
(1966 Electric heating elements)



Silicone heaters, heat-tracing tape, foil for heating surfaces and drums (Ultimheat catalog, 2012)

Because of permanent improvement of our products, drawings, descriptions, features used on these data sheets are for guidance only and can be modified without prior advice



# Historical introduction

## Part two: Technological evolution of heating elements

### Metal heating wires

When Camille Hergott developed his first flexible heating elements, his research focused around nickel conductors. He made this choice because of the high temperature coefficient, making it rustproof and self-regulating (thanks to its double resistivity between 20 and 200°C). Other metals used at the end of the 19th century for heating elements were platinum (expensive), iron (oxidizable), nickel silver (low temperature coefficient), copper (very low resistivity).

Ferro-nickels, which appeared shortly thereafter, made it possible to limit the length of the heating wires required, because they had greater resistivity. The most resistive alloy used for heating elements was 30% iron and 70% nickel. Its resistivity varied little with temperature (temperature coefficient of temperature 0.0009°C i.e. 5 times less than pure nickel at 0.0054). They were basically rustproof at high temperatures, and so were mainly used in stoves, radiators, and toasters.

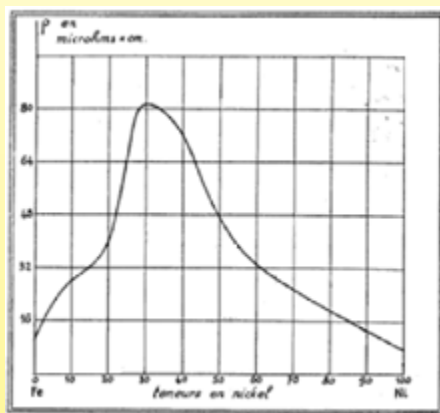

Variation in resistivity: curve versus nickel content in ferro-nickel alloys (La Nature, 1934, Nickel alloys and their applications, P215)

The development of nickel alloys from 1900 to 1940 gave rise to nickel-chromium resistive alloys and multiple copper-nickel alloys. As for ferro-nickels, high resistivity and temperature resistance were the main parameters for using these products. The alloys also had to have a low temperature coefficient, such as constantan and Driver-Harris Advance, so that their characteristics were not affected by temperature. Their use in heating blankets and thermoplasms required the addition of a temperature-limitation system.



1930 Electric compresses with Advance heating elements (Drivers Harris, 1930 catalog, Ultimheat Museum)

ALLIAGES R. N. C. POUR RÉSISTANCES ÉLECTRIQUES			
Propriétés	R.N.C.-1	R.N.C.-2	R.N.C.-3
RÉSISTIVITÉ à 20°	100 ± 4 microhms/cm	111 ± 4 microhms/cm	100 ± 4 microhms/cm
Coefficient de température de la résistivité, valeur moyenne entre 20° et 200°	+ 0,0004 par degré	+ 0,0004 par degré	+ 0,0004 par degré
Perte de chaleur par rapport au nickel	+ 0,5 à 0,5	+ 0,5 à 0,5	+ 0,5 à 0,5
Densité	8,45	8,45	8,45
Point de fusion	1.420°	1.420°	1.420°
Température limite d'emploi	1.000°	1.000°	1.000°
Applications	Éléments chauffants pour températures élevées, Outils chauffants, Chauffage domestique.	Radiateurs, Chauffage des températures élevées, Fuses à retardement, Appareils de mesure.	Radiateurs, Chauffage des températures élevées, Appareils de mesure, Éléments de mesure.

Because of permanent improvement of our products, drawings, descriptions, features used on these data sheets are for guidance only and can be modified without prior advice



## Historical introduction

1933 Imphy's mills offer resistive wires in 3 different nickel-chromium alloys, which they call RNC 1, 2 and 3 (Resistive Nickel Chrome). RNC1 was well suited for heating blankets. It had a large increase in resistivity relating to temperature, which provided a self-regulating effect (0.0030 to 0.0035  $\Omega/\Omega/^\circ\text{C}$ )

Around 1934, Driver Harris produced a 28% iron and 72% nickel alloy with a high temperature coefficient, called Hytemco. (High Temperature Coefficient). This alloy had a temperature coefficient of 0.0048 to 0.0053  $\Omega/\Omega/^\circ\text{C}$ , making it very close to pure nickel. But its resistivity was twice as high, which made it possible to reduce the length of the necessary wires. Used in heated blankets, it provided an important self-regulating function.

Over the years, Harris developed a range of alloys with a high temperature coefficient, in particular:

- 99 alloy: (99.8% pure nickel): 0.006  $\Omega/\Omega/^\circ\text{C}$
- Nickel grade A: 0.005  $\Omega/\Omega/^\circ\text{C}$
- Nickel grade E: 0.0045  $\Omega/\Omega/^\circ\text{C}$
- Hytemco: 0.0045  $\Omega/\Omega/^\circ\text{C}$
- Permanickel: 0.0036  $\Omega/\Omega/^\circ\text{C}$
- Alloy 152: 0.0035  $\Omega/\Omega/^\circ\text{C}$
- Alloy 146: 0.0032  $\Omega/\Omega/^\circ\text{C}$

Similar alloys were developed by other metallurgists under the names Alloy 120, MWS-120, Balco, HAI-380, NIFE 5200, Kanthal 70, Alloy K70, Nifethal 70; Pelcoloy.

In 2015, Driver Harris's Hytemco ferronickel alloys, now called PTC alloys, were standardized in China (Standard JB/T 12515-2015) according to their temperature coefficient, to allow a better approach to creating self-stabilizing temperatures in heated blankets. Depending on the model, their temperature coefficient varies from 0.003 to 0.00465  $\Omega/\Omega/^\circ\text{C}$ .

Alloy code*	Nominal composition%		
	Fe	Cr	mn
P-4650	18.0	82.0	-
P-4350	19.0	81.0	-
P-4050	20.0	80.0	-
P-3750	21.0	79.0	-
P-3550	20.2	79.0	0.8
P-3350	22.0	78.0	-
P-3150	23.0	77.0	-
P-3000	21.5	77.0	1.5

Table of the composition of nickel alloys with PTC effect (Standard JB/T 12515-2015)

\* The 4 digits after the letter P give the nominal value of the temperature coefficient. For example 4650 = means 0.004650  $\Omega/\Omega/^\circ\text{C}$

### Manufacturing methods of blanket heating cords

In 1949, Léonard Julien Degois of Limoges, studying the reasons why the blanket's heating wires would break, developed a new method of winding the heating conductor on a textile core. He proposed double-winding in opposite directions, so that the windings would intersect. The cords no longer buckled. He went on to implement this technique at Jidé, which was founded soon after, manufacturing heating blankets. With this invention he came to be known as "the inventor of heat blanket resistors"

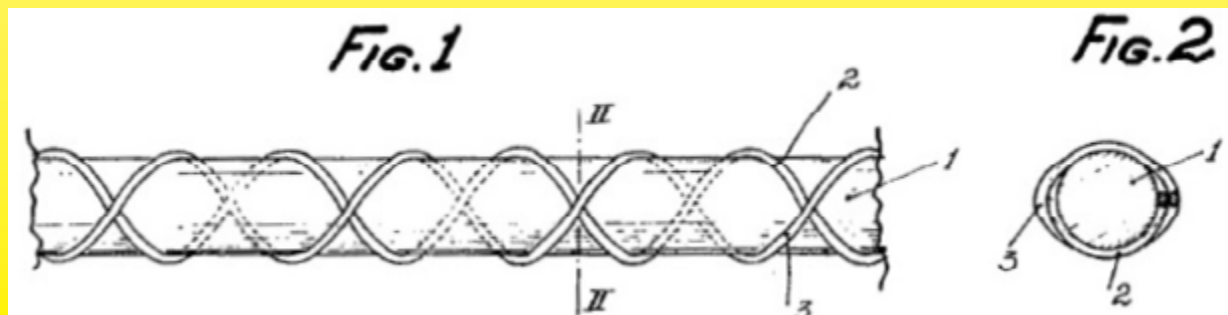

1949 heating wire with crossed winding (Léonard Julien Degois patent)

Because of permanent improvement of our products, drawings, descriptions, features used on these data sheets are for guidance only and can be modified without prior advice

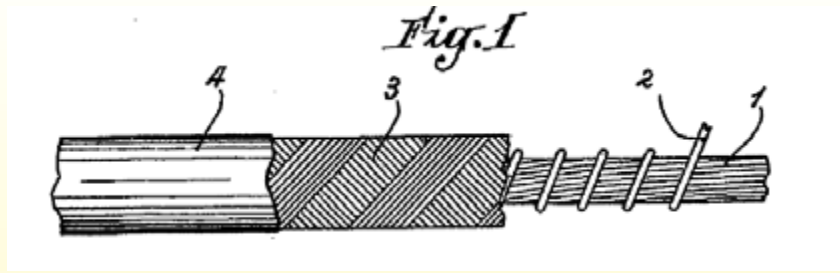

As early as 1949, Tissélec filed a first patent for a heating cord whose outer covering (3) was covered with a rubber, pvc or polyethylene type elastomer (4) in order to improve insulation, particularly in cases where the cover was wet. (Patent FR 982675 registered on June 13, 1951)

Around 1955 in France, Hytemco self-regulating alloys were first released from several heat blanket manufacturers. This eliminated the need for safety thermostats. In 1958, one of the largest French manufacturers, Electro-Rivoli (Vedette brand), stated that its regulation system was run by Swedish self-regulators (Most likely Kanthal 70, also known as Nifethal 70).

From then on, the two different systems both existed in thermoplasms and heated blankets.

- The first used low temperature coefficient, like nickel chrome 80/20 or copper-nickel, connected to temperature limiting thermostats.
  - The second used heating wires with a high temperature coefficient, very close to nickel, such as Hytemco, Balco and Kanthal 70, which did not require a thermostat. Pure nickel, which was used originally, lost its appeal. This was because of its resistivity, which required the use of twice as much wire.
- The technical choice of manufacturers between these two solutions was purely economical, and they are still in use today.

In the 1960s, most of the heated blankets used a 7W/m heating cable and most of the manufacturers changed from chrome-nickel or nickel wires to self-regulating wires.



1960 ca. Guipage workshop for heating cords used in electric blankets (Ultimheat Museum)



1960 ca. Calor heating cord, diameter 1.7mm, single nickel chromium heating wire, diameter 0.08mm, on a slightly twisted cotton core to prevent buckling (Ultimheat collection)

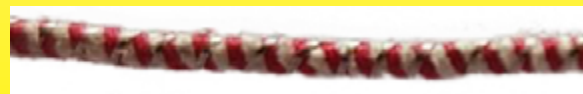

1960 ca. "Sef-regulating" heating cord from the brand Ellesert, diameter 1.2mm. The central core is a straight cotton thread surrounded by a guipure consisting of two 0.1mm diameter cotton threads wound with a 0.8mm pitch. There is then a 3 0.067mm nickel conductor guipure wound with a 0.8mm pitch in the opposite direction. This keeps the whole unit from looping (Ultimheat Collection)



1962 ca, Jidé brand heating cord. Sewn directly onto one of the sides of the heating blanket, no longer between two fabrics, it has four spiral nickel conductors on a cotton core, which are then covered with a very fine wrapping, and then with a cotton braid. The unit is not waterproof and very combustible.



Measuring heated blanket surface temperature (1960 ca, Vedette, Ultiheat Museum)



Flexible, PVC-insulated heating wire with a very small diameter (2mm), single conductor diameter 0.11mm copper alloy (probably nickel silver), wound on polyester core dia 0.5mm, used on a General Electric heating blanket (England), around 1962. The unit is very combustible. (Ultiheat Collection)

In 2019, heating blanket heating cords are composed of a fiberglass core (sometimes polyester fiber), surrounded by a spiral heating wire. The system is then covered by flexible insulation, based on high temperature PVC, resistant to 100°C. This solution is the least expensive and the most common. A more professional and almost incombustible solution consists of a fiberglass core, a spiral heating wire and silicone elastomer insulation resistant up to over 200°C.

### **Self-regulating polymer heating cables with positive temperature coefficient**

In 1962, an important discovery was made at Douglas Aircraft laboratories (US Pat. No. 3,238,355) on polymers and, in particular, on polyethylene loaded with carbon nanoparticles, which is a semiconductor at ambient temperatures. It was found that this material, at a temperature of around 70°C, saw its resistivity rise sharply as a quasi-electrical insulator

(“Electrical Properties of Black Carbon Filled Polyethylene”, Polymer Engineering and Science, Jun. 1978, vol. 18, No. 8, pp. 649-653. “Polyethylene / Carbon Black Switching Materials”, Journal of Applied Polymer Science, vol. 22, 1163-1165, 1978, Wiley & Sons, NY)

As early as 1966, General Electric engineers Phillip A. Sanford and William P. Somers devised flexible conductors using this property to make resistors for heated blankets. This eliminated the need for safety limiters, as the heating pad adjusted its power automatically as soon as the temperature became too high. The most comfortable power for the heating cords in ambient temperature was found to be 3 to 3.8 watts per meter.

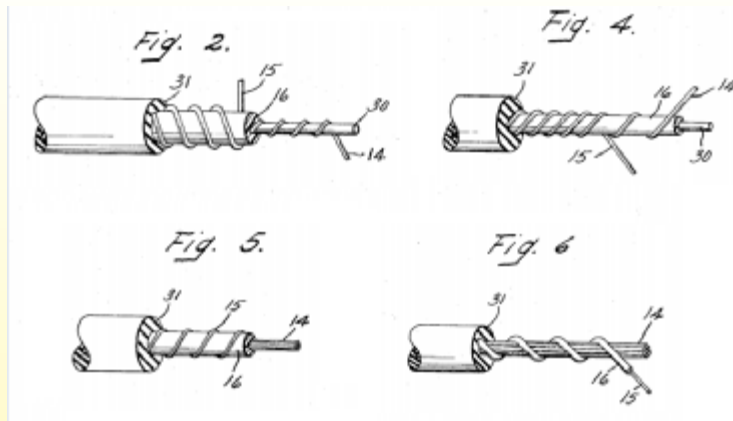

1966 First self-regulating heating cords for electric blankets  
(US Pat. No. 3410984, Phillip Sanford, for General Electric)

Depending on the composition of the polymer, its percentage of carbon particles and its thickness, it was possible to obtain different stabilization temperatures. However, in addition to its cost, the lack of flexibility of this highly charged 27% carbon polymer made the heating cords relatively stiff, and lacking the flexibility required for heating blankets.

In addition, two major technical problems quickly emerged that prevented commercialization.

The first was related to the high contact resistance between the conductors and the polyethylene semiconductor, due to the difficulty of joining the two. The second problem was the poor stability of the heating element, which had lower resistivity, presumably because of the high operating temperature and thermal cycles. It took more than 10 years to resolve, and it was not until 1980 that Sunbeam, the American heating blanket manufacturer, filed patent 4271350 for a reliable version of heating cables with a positive temperature coefficient. In this technical evolution, the heating cord underwent a thermal annealing cycle at a temperature of 150°C. This was greater than the melting temperature of polyethylene, which required a high-temperature over-sheathing of thermoplastic elastomer and special precautions so that the conductors did not touch during annealing. Sunbeam's various versions of electric blanket applications also improved the flexibility of the heating cord.

At the beginning of 1984, Sunbeam heating blankets using this type of conductor, without thermostats, appeared on the American market.

This technology continues to be used almost exclusively by Sunbeam in the USA. It allows production of blankets with high calorific value, but, although reduced, the original defects are still present, such as lack of flexibility, and loss of heating power following aging of the PTC polymer.

### Carbon fiber resistors

Known since 1860 from the work of British chemist Joseph Wilson Swan, it was in 1879 that carbon fiber first came into commercial use, when Thomas Edison produced it from bamboo fiber to make incandescent light bulbs.

Carbon, in the form of graphite electrodes, was also widely used in film projectors and industrial furnaces.

Carbon filaments were used on incandescent lamps until the mid-1930s, before being gradually replaced by tungsten filament lamps that appeared around 1910.

The manufacture of carbon fiber bundles for industrial uses required a period of about fifteen years of development to find new production techniques. These fibers only started being used in the 1970s. It allowed the development of carbon fiber composite laminates and resins, which remains its most popular application, but also that of resistive electrical conductors.

The first low-voltage carbon fiber heating blankets appeared around 2008.

Variable according to the manufacturing process, carbon fiber has a resistivity ranging from 900  $\mu\Omega\cdot\text{cm}$  to 1650  $\mu\Omega\cdot\text{cm}$  (which explains the differences in resistivity between manufacturers). This resistivity is about 10 times higher with 80/20 nickel chromium (112  $\mu\Omega\cdot\text{cm}$ ). Its temperature coefficient is close to zero. The carbon conductors are mostly made by 1000°C carbonization of viscose or polyacrylonitrile filaments (PAN). The current diameter of the filaments is 7

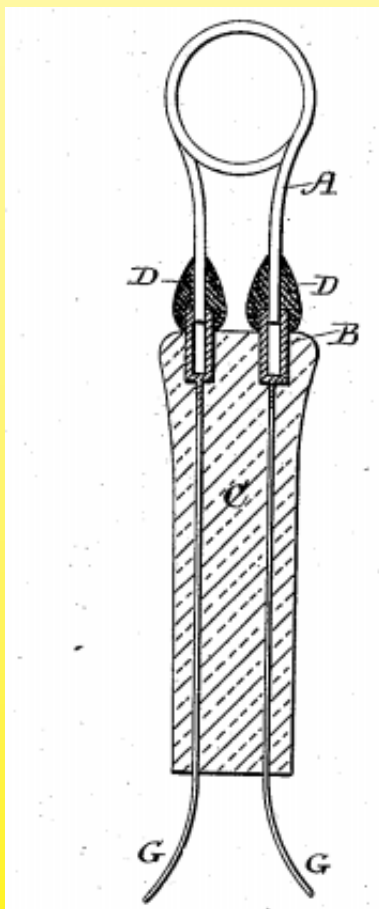

1881 carbon filament lamp, improved methods of connecting the filament to the electrodes (English Patent No. 4.202 of 29 September 1881, by Joseph Wilson Swan)



## Historical introduction

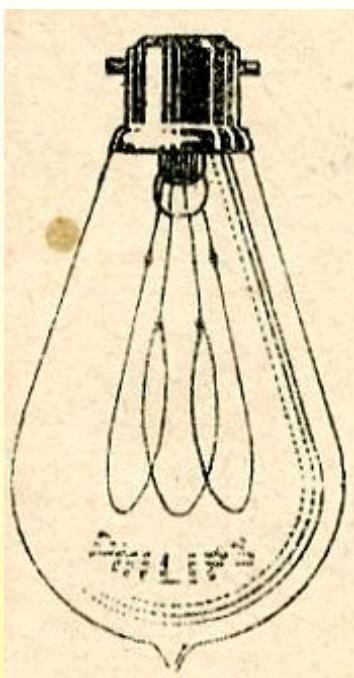

Philips filament lightbulb (1930, Philips Electric Omnium catalog, Ultimheat Museum)

microns. Before carbonization, they are cut into wires that have between 1,000 to 48,000 filaments. These wires designated by the letter K, preceded by a number giving the number of thousands of filaments (1K, 3K, 6K, 12K, 24K, 36K, 48K). Conductor resistance in Ohms per meter is inversely proportional to the number of filaments, and varies from 500 Ohms per meter for the 1K cable to 10 Ohms per meter for the 48K cable (approximate values according to the manufacturers). Of course, the diameter of the cable increases with the number of filaments. A 3K insulated silicone cable will be around 2mm in outer diameter, while a 48K cable will be 5.5mm.

In domestic heating blankets, which have a power around 50 to 150W, there are limiting factors, such as the diameter of the cable and the length necessary for a good distribution of heat. Flexibility, even with silicone insulation, becomes too limited when the application requires cables with a large number of filaments. In industrial applications, the high electrical resistance in Ohms/m makes applications in powers above 300W difficult, requiring parallel wiring of multiple heating elements.

For these reasons, the main standard applications for flexible carbon fiber wires are in electric underfloor heating, where the usual values of 200W/m<sup>2</sup> are possible to achieve, and flexibility and resistance to repeated flexing are not within the critical parameters. The connections are also a handicap, because it is difficult to connect carbon fibers with copper-connecting conductors because the filaments are fragile and can break when crimping terminals, and then cannot be soldered. In most cases, silver-charged and expensive conductive resins are required to make these connections.

Since carbon has no self-regulating action, it is also necessary to provide a temperature limitation system when being used for heating.

In these applications, carbon fiber is also sometimes produced in the form of felt, ribbon or filaments introduced when manufacturing the fabrics.

The latest edition of standard IEC 60335-2-17 of 2012 on heating blankets expressly provides carbon as a heating element, in the form of conductive wires or electrically conductive textiles.



2019 Carbon fiber heating wire, with PVC insulation, in 12K and 24K (Ultimheat collection)

### Recent technological developments of flexible heating conductors.

- Polymer ribbons with conductive plating: these ribbons are spiraled around a fiberglass core. With their extreme flexibility, they can create small diameter cords that can be incorporated into fabric manufacturing
- Metallic micrometric tapes wrapped around a core of cotton, synthetic fiber or fiberglass: They also allow the creation of cords with a very small diameter (up to 0.27mm), which can be easily integrated into fabrics (2004)
- Self regulating silicones: these silicones comprise a filler in carbon nanoparticles, similar to PE and PP (US Patent: 6.734.250 of August 17, 2000 Shin Etsu chemical).
- Polymeric fibers with surfaces metalized by plasma or electroplating.

Because of permanent improvement of our products, drawings, descriptions, features used on these data sheets are for guidance only and can be modified without prior advice



# Historical introduction

## Part three: Adjustment and temperature control

### Power adjustment by switches

During early medical applications of electric blankets at the end of the 19th century, there appeared to be a need for heat regulation. The first solution put into practice was to use several heating circuits, and to connect them according to the desired temperature. The oldest ones, made from Bakelite, only connected one or two resistors using a pear-shaped switch, similar to that used for lighting.

The first three-switch heating models appeared in the 1930s  
(Bouchery Catalog, 1933)

The simplest models of electric blankets, up into the 1960s, often had no switches at all. The instructions simply asked the user to unplug it when the bed was warm. The fierce competition of the years 1960-1970 forced many manufacturers to install switches on the power cable. As well as having an off switch, the rotary switches also had switches with 3 power levels, while requiring only two standardized heating elements. The early 1970s saw the replacement of rotary switches with more aesthetically pleasing slide switches.

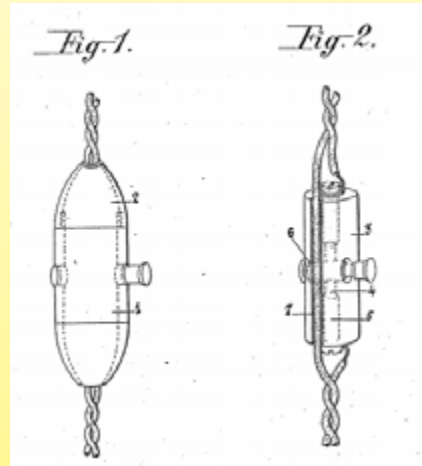

1921 On/off switch on thermoplasme (Fare Catalog, Ultimheat collection) 1924 Switch for flexible wires (Patent Arzens75051). In 1933 Calor develops a similar model with snap-off technology

Until 1925, Calor used a simple switch on some of its flexible heating fabrics (Thermoplasms, bottle warmers), and then advanced to a multi-position setting switch on its thermoplasms.



1929 Calor Thermoplasma with adjustment (Advertising)

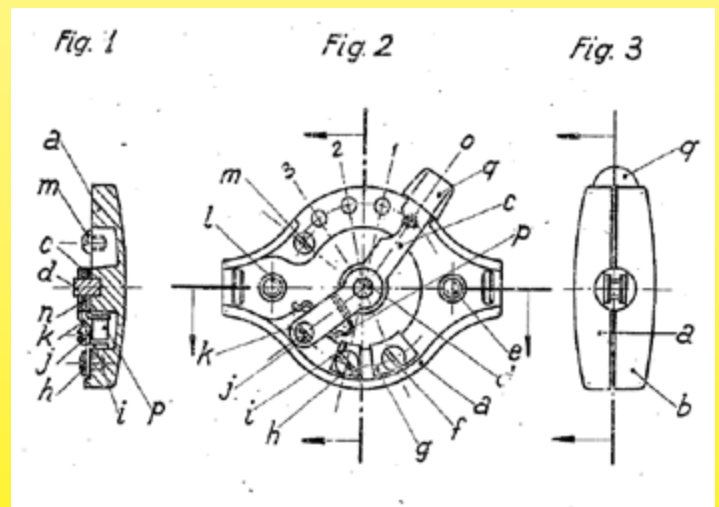

In January 1943, the Parisian Roger Marcel Cuche invented a 5-position rotary switch, including 3 heating levels, with a design that was universally used on electric blankets for more than 30 years. The 0 position at each end of the slider avoids user errors, especially at night. (French patent 890417A)

Because of permanent improvement of our products, drawings, descriptions, features used on these data sheets are for guidance only and can be modified without prior advice



# Historical introduction



Because of permanent improvement of our products, drawings, descriptions, features used on these data sheets are for guidance only and can be modified without prior advice

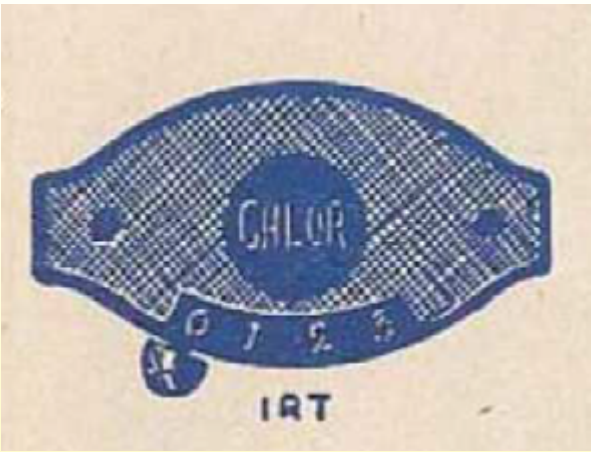

1947 Switch with 4 setting positions for thermoplastms. The 4 positions would then become 5, with a stop on each side to avoid positioning errors at night (Calor spare parts catalog, 1947, Ultimheat Museum)



1955 ca. 5-position rotary switch similar to the Cucho model, but with snap-off switch (German manufacture LW Lohmann and Welschehold GmbH & Co. at Meinerzhagen)( Ultimheat Collection)

3 or 4-position slide switches replaced the rotating model and became the standard for electric blankets from the 1970s

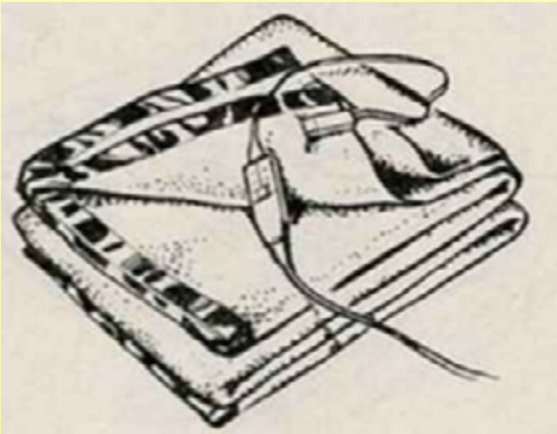

Three-way slide switch (1961 Calor)



Calor switch, 3-speed and slide-off position (Ultimheat collection, circa 1961)



3-position heating switch and 2-position stop switch on heating blanket. Intermediate model between rotary systems and slide systems (1970 ca. Gitem Ultimheat collection)



Three-position and stop slide switch, circa 1990 (Ultimheat collection)



## Power adjustment by energy metering

The problem of continuously setting the power was reminiscent of similar issues with electric hotplates, which were being developed at more or less the same time. There was no electrical or electromechanical solution to temperature measurement inside the heating blanket, as the setting was outside it in a control unit. The first models of this type, which were intended for electric stove tops, were made in England by Sunvic in July 1938. By 1936, one company had introduced a heated quilt with an automatic temperature control. A bedside thermostat responded to temperature changes in the room and cycled the blanket on and off accordingly. These early electric blankets also included several safety thermostats which would switch the blanket off if a portion of it became dangerously heated.

In 1942, Leonard W. Cook of General Electric USA, the largest manufacturer in the US at the time, invented the temperature control system that would become the most common for heating blankets. US Patent 2,383,291 was accepted in 1945.

As with Sunvic's energy meter, the control system included a bimetallic strip heated by a small, low-watt electric resistor, mounted alongside the main resistor. The setting, which worked based on the distance from which the bimetal warped in order to actuate contact, allowed the main resistor's power to be set remotely by varying heating cycles. This system was also sensitive to room temperature.

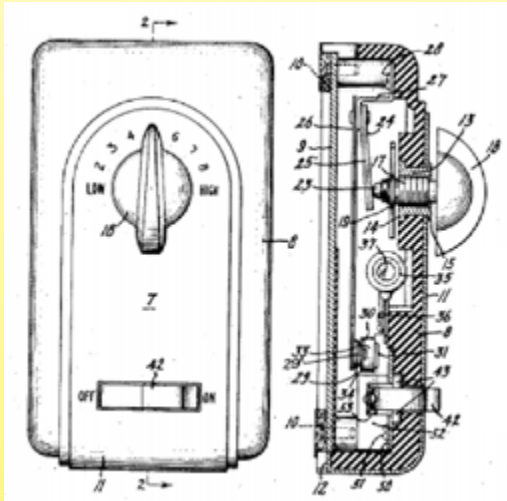

System for regulating the power of bimetallic heating blankets and additional resistance in the casing (1942, Cook patent)



**Exclusive G-E Bedside Control**—set it *once a season* —for the nightlong warmth you want. At bedtime, just turn blanket on. If room temperature changes, Control adjusts automatically! Bed (and you) stay comfortably cozy all night—every night!

1946: General Electric's advertisement for their new temperature control system

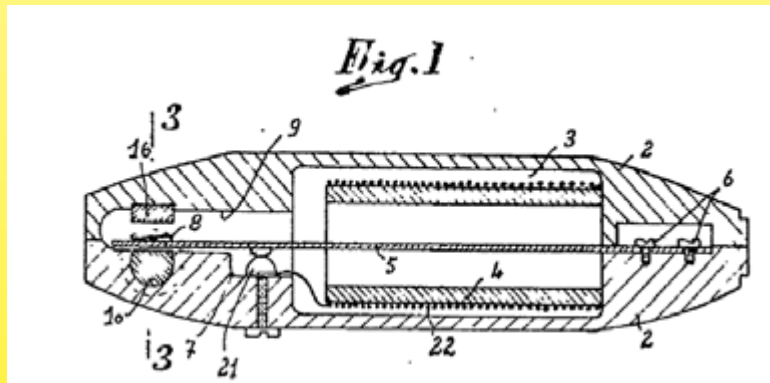

In 1954, Maurice Pierre Marchal working at Tisselec, filed a patent for a bimetallic switch. This product used a small series resistor (No. 22) on the heating blanket and slowly heated a bimetallic strip (5). The aim of this invention was to create a heat timer that automatically turns off heat after a certain duration. Marchal completely failed to achieve gradual heating control, although his system came very close to this idea.

Around 1960, French heating blankets were fitted with control units mounted on the equipment power cable, based on General Electric's Cook system.

Airaile named it Variotherm and Calor made it available in its high-end appliances, highlighting its setting and sensitivity to room temperature.

Because of permanent improvement of our products, drawings, descriptions, features used on these data sheets are for guidance only and can be modified without prior advice



# Historical introduction



1961 "Textorève" Control unit, General Electric USA adjustable system, sensitive to temperature variations, but still with a slow cut-off (Catalog Calor 1961, Ultimheat Museum)



1970 ca. GEC power setting (General Electric, England) on an English heating blanket. Anticipated resistance is clearly visible above the bimetal and slow breaker (Ultimheat Collection).



1972 ca. Power control box made by Jidé in Limoges under the brand Jidéstat. **The most successful of all systems.** Very small in size, it is adjustable, and is incorporated in the electrical plug. This is the only model with a snap magnet contact. It was not surpassed by electromechanical systems until the current era. (Ultimheat Collection)



1995: An American power meter heating blanket, similar to that developed more than 50 years earlier by Cook in 1942. Exterior view and view of the internal bimetal has a slow breaker with anticipated resistance. The only notable development in this model is that it includes a noise filter (Collection Ultimheat)

From the 1990s, the miniaturization of electronic components made it possible to make smaller setting systems. These incorporated not only the on-off switch, power control, and temperature control, but also dimming functions and "on" and "off" timer functions.



2019 Continuous Electronic Power Control Blanket Control Unit (Ultimheat Collection)



2019 Continuous Electronic Power Control Blanket Control Unit (Ultimheat Collection)



2019 Control unit for temperature-controlled heating blankets with digital display via a thermistor probe incorporated into the heated area (Ultimheat Collection)

## Temperature limiters

The first example of a temperature limiter in a flexible heating element was developed by Camille Hergot in 1902. It consisted of a conductive portion of the current made of fusible alloy at 70°C. This solution led to the disuse of this device.

In 1912, William Hoffmann of Detroit (USA) put forward a patent for a flexible heating circuit with two different control systems: a bimetallic system, which provided temperature regulation, and a safety switch system which worked by combining a low temperature alloy welded to 2 blades. It seemed unlikely that this patent would be followed by actual manufacturing, because the design of the thermostat did not allow for proper operation.

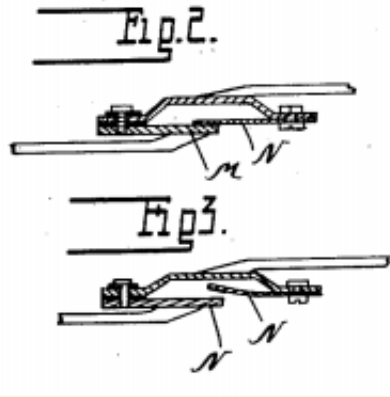

1912 Hoffmann fusible alloy limiter for heating blanket (US Patent 1096916). The fusible alloy welds together blades M and N

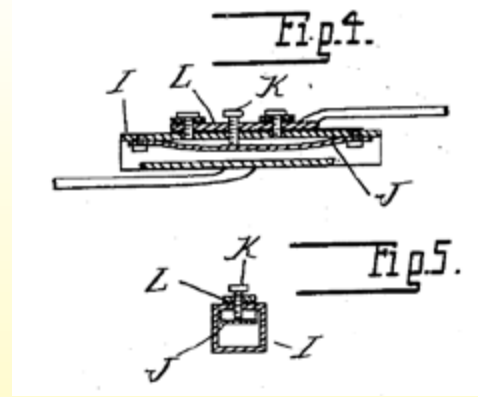

1912 Hoffmann Bimetallic Thermostat for Warming Blanket (US Patent 1096916) J is a bimetallic blade riveted at both ends. The electrical contact is supposed to open between blade J, deforming when the temperature rises, and set screw K

During the years that followed, and up to the Second World War, despite the existence of some patents, there is no mention of temperature limiters in manufacturers' records. It is simply stated that the heating blanket must be turned off when the bed is hot, and must not be operated continuously.

From the 1930s, the development of bimetallic manufacturing techniques in the USA allowed the manufacture of small temperature limiters. The low breaking power required in these applications (between 50 and 150W) meant that they could be made much smaller.

In the years 1955-1970 the size of the market (between 300,000 and 600,000 heating blankets produced per year in France) led engineers to find specific technical solutions.

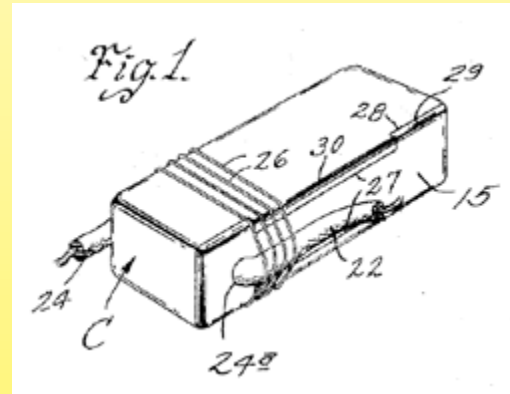
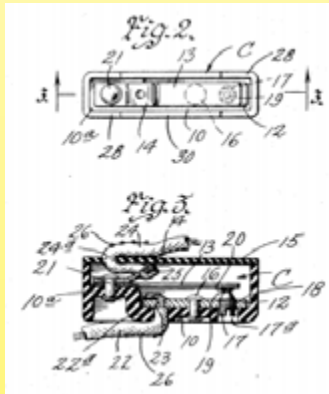

In November 10, 1941 in Saint Louis, Laurence Howard filed a patent (US 2,328,342) for a miniature slow-breaking heating blanket thermostat and protective housing, including a device for protecting against wire tearing (for the company Knapp Monarch de Saint Louis).

In 1944, engineer Sidney Arthur Singleton, on behalf of heating blanket manufacturer Thermega Ltd in London, developed a miniature snap-action limiter for heated blankets (1944, May 3, British Patent 609,082, registered in the USA in 1948).

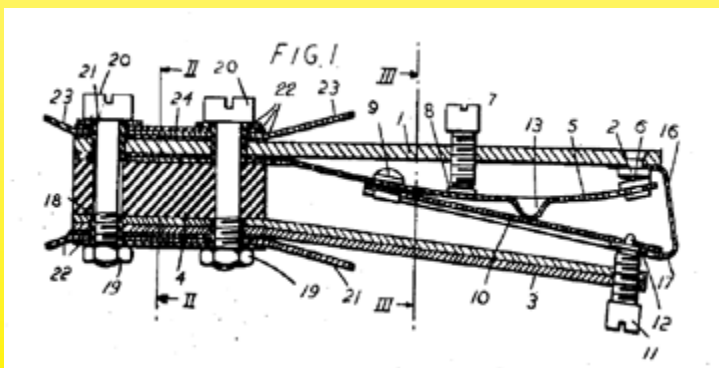

1944 Thermega fast break limiter for heating blankets

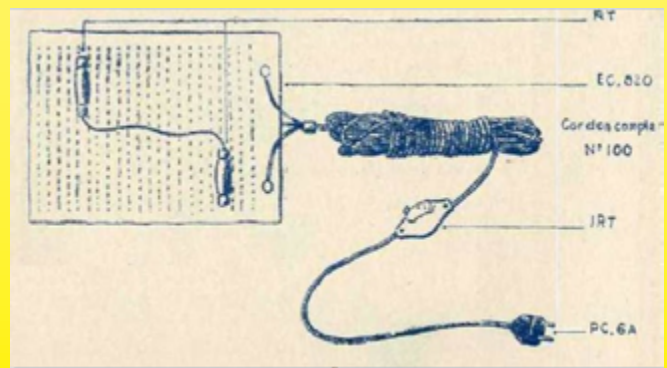

1947 Thermoplasma Calor, view of the heating part with its two protected sheath thermostats (RT) and its 3-position switch (IRT). (Cat Ultimheat)

Because of permanent improvement of our products, drawings, descriptions, features used on these data sheets are for guidance only and can be modified without prior advice



# Historical introduction

Because of permanent improvement of our products, drawings, descriptions, features used on these data sheets are for guidance only and can be modified without prior advice

Thermostats and temperature limiters became mandatory in heating blankets because of the changes brought by NFC 73-147 in 1957. It required at least two of them in models using conventional non-self-regulating resistors. Their role was to avoid overheating, especially if the cover (or thermoplasm) was folded over itself, or covered by a quilt. These thermostats were subject to a major technical restriction - they had to have a low temperature range (from 1 to 2°C) to ensure that the cover heated up again once the defect was eliminated. This restriction made it technically impossible to achieve using small-size snap limiters. The only devices that met these criteria were slow-break limiters, which combined small size with a small temperature range. In 1955, when Calor put its heating blankets on the market under American licensing, they were slow-acting limiters, working perfectly in the 110V network in the USA where they were used. These limiters were protected from dust, moisture and insulating felt particles by a small waterproof PVC bag, and this caused them to create radio interference. The gradual transition from 110 to 220V in the 1960s only increased interference.

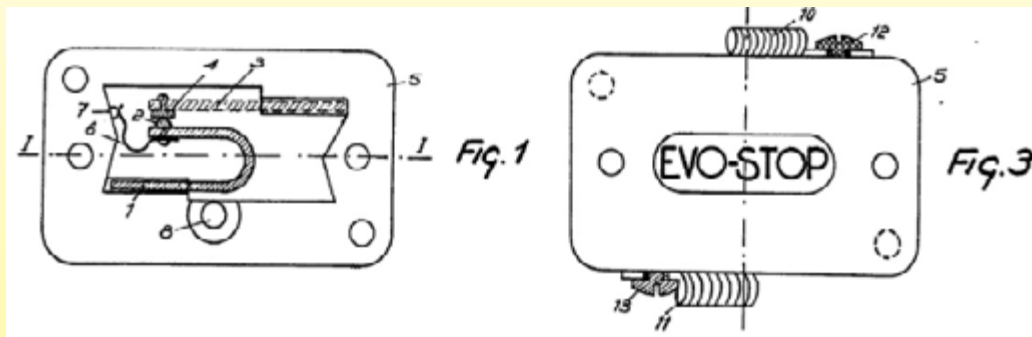

In 1957, Maurice Georges Moïse Gervaiseau, a thermoplastics manufacturer (151 Georges Durand Avenue, Le Mans), developed a compact bimetallic thermostat, under the brand name Evo-Stop, in a closed unit with an improved slow breaker, in order to overcome the problem of radio interference and was specifically intended for heating blankets. (Patent 1169253)

Another problem with temperature limiters was their conductors' mechanical resistance to traction. In 1958, to overcome this defect, Maurice Pierre Marchal of Tisselec, proposed to completely wind the conductors around the thermostat.

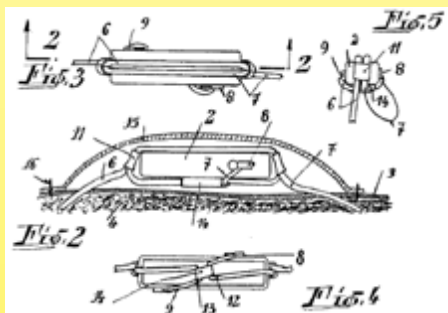

1958 Installation method of the limiters to prevent weld breaks on the thermostat (Patent Tisselec 1.204.242)

1960 Rhonéclair releases its heating blankets with 2 thermostats with NF-USE-APEL marking, and also a line without thermostats, and therefore without the NF mark

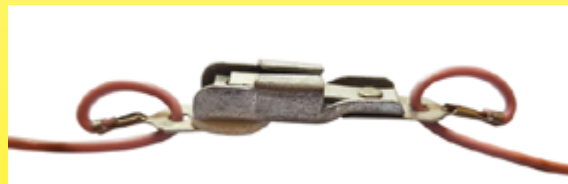

Calor slow-break heating blanket temperature limiter, calibrated at 80°C (circa 1960). Note the waterproof PVC sleeve welded on the wires and the loop made by the electrical conductors passing through a hole in each terminal- this is to eliminate tensile stresses on the wire (Ultimheat Collection)



Slow-breaking heating blanket temperature limiter, used in conjunction with an English power control system made by GEC (General Electric Company). It is covered with a waterproof PVC sleeve, welded to the wires. Around 1970 (Ultimheat Collection)



# Historical introduction

The 1960s and 1970s saw the emergence of many miniature snap switch temperature limiters, made by companies such as Augé and Cie and Imphy (France), Texas Instruments (USA), Portage Electric, (USA), and Uchiya (Japan), but their success was very limited in the field of domestic blankets, because their temperature ranges were too great.

In 1959, engineers Walther H. Moku and Henri David Epstein of Texas Instruments USA filed a patent (3104296) for a miniature snap thermostat. This model was the first of a large line of devices of this type - the SL11 series. But despite its small size, and its tight assembly, it was seldom used for electric blankets, and found its market in engine coils.

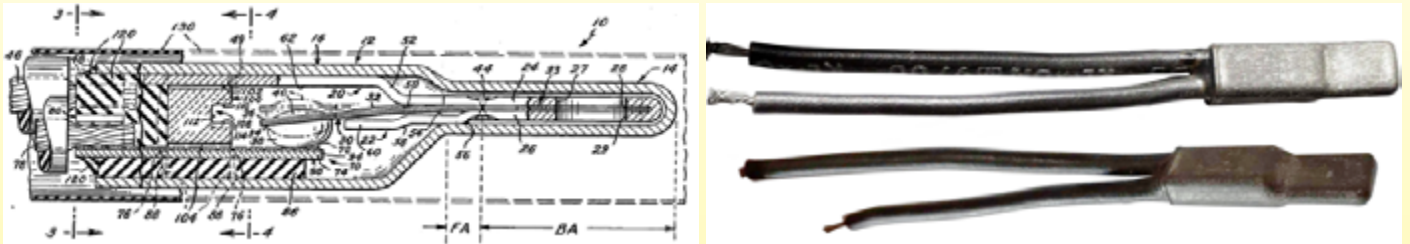

Patent Plan 3104296 and prototype of the SL11 series (1960, Ultiheat Collection)

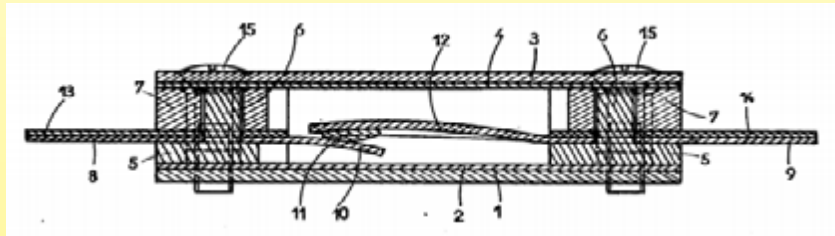

1961 bimetallic miniature snap switch for heat blankets, joint patent of Sté Auge et Cie and Imphy sa No. FR1296066 (France)

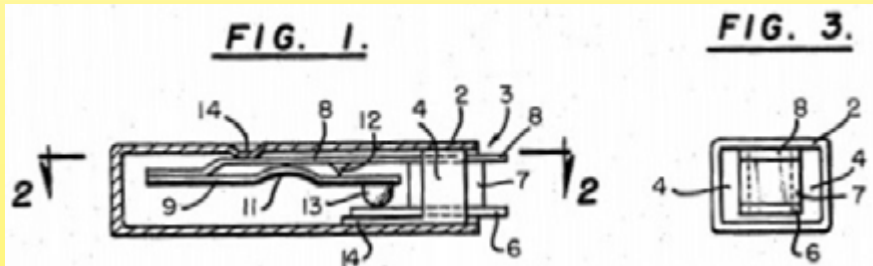

1963 Portage Electric miniature snap-off limiter (US Patent 3443259). Its main feature was to adjust the set point by a small bump in the casing (No. 14), which was taken up by most manufacturers.

In 1966, Texas Instrument's engineer Richard T. Audette developed the most simple to produce snap-off temperature limiter, which was marketed as the 7 AM series. This model combined both miniaturization and low temperature ranges. It is now manufactured by multiple manufacturers, including waterproof versions.

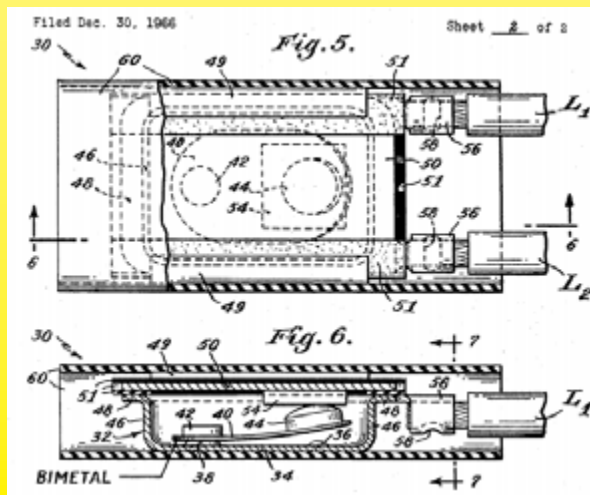

1966 Patent of Richard T. Audette for Texas Instrument (US Patent 3,430,177)

Because of permanent improvement of our products, drawings, descriptions, features used on these data sheets are for guidance only and can be modified without prior advice

# Historical introduction

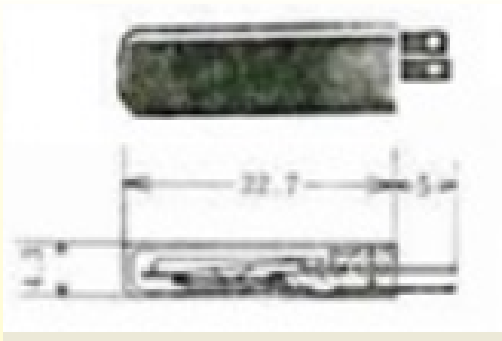

1978 Uchiya develops the miniature limiter 8X5, (22.7x4.4x 6.8mm) with snap-off, for blanket heaters. Its waterproof version became the UP32 model (Ultimheat Museum Catalog)



1980 ca Uchiya UP32 waterproof bimetallic limiter on Gitem private label heating blanket. (Ultimheat Collection)

In 1964 Portage Electric developed its slow-breaking E model, similar in appearance to the B and C models in its range. As the applications in heating blankets developed, in 1984 it created a specific model for this application, which was flat, with a crimp terminal at each end - the A1 model. This one was approved by UL specifically for heated blankets in June 1984. Then the model E, with a new design, in 1991

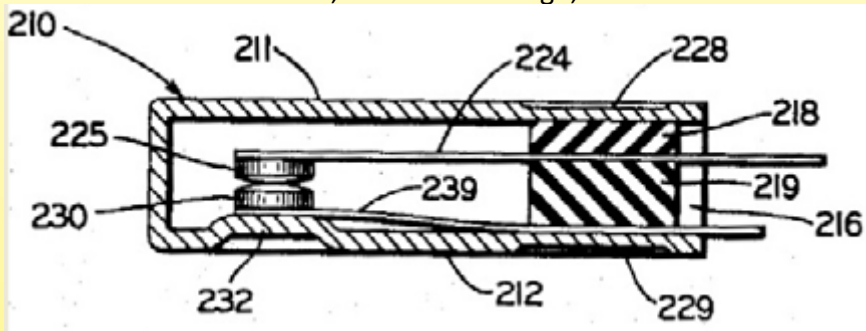

Portage Electric Slow-Breaking Thermostat Models, 1963 (Glenn Wehl US Patent No. 3,223,808)



E-type Slow-breaking Electric Portage Thermostat (1991)



2019 Snap-off temperature limiter for heating transformer, derived from the 1966 Texas Instruments 7AM model, usable at 230V, in plastic waterproof casing. Temperature range of 5 to 8°C. Type V7AM. (Ultimheat Collection)

Because of permanent improvement of our products, drawings, descriptions, features used on these data sheets are for guidance only and can be modified without prior advice



Because of permanent improvement of our products, drawings, descriptions, features used on these data sheets are for guidance only and can be modified without prior advice





Because of permanent improvement of our products, drawings, descriptions, features used on these data sheets are for guidance only and can be modified without prior advice

# Technical introduction



Because of permanent improvement of our products, drawings, descriptions, features used on these data sheets are for guidance only and can be modified without prior advice



**With the arrival on the market of many manufacturers and the spread of sales by internet without any technical specifications, popped up many products, most of time simple visual copies, without any technical validation, and the purchase of which is made most often in view of pictures and of a price.**

**With this technical introduction, we want to show that our continuous search for improvements and superior technology is the only way to provide our **professional** customers with reliable and sustainable solutions, taking into account the multiple technical pitfalls of flexible silicone elements.**

**Nothing** in the design of our devices was left to chance or approximation. Unless otherwise specified, all tests were performed in Ultimheat laboratory.

**Ultimheat is **ISO 9000-2015** and **ISO 14000-2015** certified (the latest existing versions). It is also a government **Certified High Technology Company.****



Because of permanent improvement of our products, drawings, descriptions, features used on these data sheets are for guidance only and can be modified without prior advice



## Industrial heating jackets and blankets Technical introduction

### First part : Various reheating tests

#### 1. What are the differences between industrial warming jackets and blankets and domestic warming blankets?

##### Vocabulary:

- An industrial jacket heater heating has a clamping system for attaching it to the vertical wall of a container
- An industrial blanket heater is intended to be placed on a horizontal surface, it does not have straps, but only rings around its perimeter for possible fixing.

These are the only differences between these two products.

Although these devices look like household warming blankets, their design and performance are far more complicated and their technology much more sophisticated. In particular, the following points of difference may be mentioned:

1 / - A wider operating temperature range, from -40 to + 120°C (and up to 200°C for some models) instead of +20 to + 50°C

2 / - A pitch of the heating wire network tighter to 20mm instead of 50 to 70mm, giving a better homogeneity of temperature and avoiding local overheating if the thermal transfer is bad

3 / A higher power range: 50 to 150W which corresponds to a surface power density from 0.04W/cm<sup>2</sup> to 0.06W/cm<sup>2</sup> for domestic blankets, compared to 140 to 4400W, ranging from 0.05W/cm<sup>2</sup> to 0.135W/cm<sup>2</sup> for industrial covers and coats

4 / Strong thermal insulation to prevent losses to the outside and improve their energy performance

5 / A design of thermal and electrical insulation resistant to heat, water absorption, and resistant to water jets (IP65), very rarely achieved in most domestic models

6 / Electrical insulation resistance at least 10 times higher than domestic blankets

7 / A total grounding by a metal braid external to the heating cords, forming a mechanical protection and ensuring the earthing in case of perforation or short circuit. This protection is non-existent on domestic blankets.

8 / A thermal protection of the surface temperature with anticipatory action to prevent overheating of the wall, to allow use on containers made of glass, plastic or metal

9 / A fixation on the containers by straps and safety loops for an effective tightening, easy to adjust, and incorporating a soft hood closing above, ensuring the maintenance in position without sliding.

10 / A variety of temperature control methods:

- Heating according to the outside temperature (antifreeze function),
- Heating according to the surface temperature of the tank,
- Heating according to the temperature in the center of the volume of product to be heated (To be used in addition to the heating according to the surface temperature.

These temperature control systems, in their electronic versions ensure a steady and optimized temperature rise without overheating

11 / A wide range of accessories: insulating covers, ground thermal insulator, adjustable speed stirrer, GFCl.

#### 2. Parameters acting on the duration of the rise in temperature

**The most common question users ask is: «How long does it take for your blanket to heat my drum or container?»**

To answer this question a number of parameters must be studied and the main ones are:

- **The total volume heated.**

For a given power a large volume will heat less quickly than a small volume.

- **The total power applied.**

Higher power will normally heat up faster.

- **The distribution of power.**

Heating distributed over the whole mass or on all the walls will heat up **faster than** heating located on a small surface of the tank.



## - The thermal conductivity of the liquid.

The higher the thermal conductivity of the liquid, the faster the heat is transmitted to the whole mass.

## - The heat capacity of the liquid.

Since the heat capacity represents the energy that must be applied to a mass of liquid to heat it, liquids with a low heat capacity (oil for example) will heat up, at equal power, faster than those with a high heat capacity like water).

## - The kinematic viscosity ( $\nu$ )of the liquid.

The more viscous a liquid, the fewer convection currents exist. So the heat energy is transmitted less quickly. It may be necessary in some cases to add a mixing apparatus for viscous, low-conductive products.

## - The thermal insulation.

By eliminating heat losses to the outside, the heat energy is concentrated on the tank. An insulated tank will heat up faster. The addition of cover and insulating pedestal also reduces the heating time.

- **The starting temperature of the product**, and of course the temperature to reach. The greater the difference between the two, the longer the heating time is.

## - The type of temperature control:

The temperature control can reduce the power delivered to the tank near the set point (PID control), and thus slow down the heating, but it suppresses overheating. An On-Off action control will not slow down the rise in temperature, but may cause overheating. In most cases, and because the regulation is done according to the temperature of the wall, the best regulation will be On-Off type with anticipation. In particular a poor positioning of the temperature sensor, for example in the middle of the heated liquid, increases the risk of overheating of the walls, due to the time taken by the heat energy to reach the center of the container.

## - The maximum admissible temperature on the wall:

The thermal safety limiters installed in the heating blankets limit the temperature reached by the heating element or the wall of the container in order to prevent their destruction by overheating. This limitation can increase the duration of the heating, in particular when the thermal exchanges with the liquid are bad, because of the thermal conductivity of the wall of the container, that of the liquid or its viscosity.

## - The type of heating:

It can be, according to the suppliers, by conduction, by radiation, and even by induction.

The conduction solution is the most common and the most economical.

## - The material of the walls of the container:

Barrels and drums can be metal, like painted steel or stainless steel. Although having a very different thermal conductivity, these materials withstand surface temperatures above 100°C.

There are more and more barrels and containers made of thermoplastic material, obtained by different modes of molding, but all of them have in common their softening when the temperature increases. The most common in barrels, drums and IBCs for industrial use is HDPE (high density polyethylene), often given for a maximum temperature of 80°C, but also Polypropylene, Polyamide, PBT and many other thermoplastics. As a general rule, for plastic containers, the surface temperature must not exceed 70°C and 50°C for glass carboys.

## - Access to the surface of the container:

The best case scenario is when the heating blanket is in direct contact with the container wall. The worst case occurs when there is a layer of air between the wall of the cover and that of the container. This latter configuration is most often observed in IBCs, as these are often reinforced by an external metal cage that prevents direct contact with the wall.

## - Thermal gradient between the center and the bottom of the tank:

This thermal gradient can reach 20°C, and the temperature is commonly 15 to 17°C lower in the tank bottom in the case of 55 gallons metal drums heated between 80 and 100°C without mixing. When the metal containers are placed on the ground without thermal insulation of the soil, this difference is increased by several degrees.

## - Thermal gradient between wall temperature of the heating blanket and the center of the tank:

This thermal gradient is a function of the conductivity of the tank wall, the thermal conductivity of the liquid and the heating or temperature maintenance time and convection currents in the liquid. In the absence of stirrer, or temperature-corrected control in the center of the liquid, differences of 10 to 30°C are commonly observed. This is the reason why we did some of the tests with stirrer. The regulation according to the temperature in the center makes it possible to stop a reheating cycle when the product has reached a precise temperature in its center, **but cannot substitute for reheating according to the temperature of the walls.**



# Technical introduction

## 3. Examples of the most usual containers heating time in different configurations.

### 3-1. With small plastic containers

**Fluid:** Water  
**Container:** 20 liter HDPE plastic can  
**Power:** 150W (Surface Load 0.05 W/cm<sup>2</sup>)  
**Thermal insulation:** 20mm of NBR-PVC foam, covering the entire cylindrical surface.  
**Insulating lid:** no  
**Insulating base:** no  
**Electronic control:** On-Off with anticipation, with set point set at 60°C  
**Surface temperature:** Limited to 60°C by a safety thermostat.  
**Test conditions:** start at 25°C, stop when the temperature at the center of the tank reaches 50°C  
**Heating time:** 15h29 min

**Fluid:** Hydraulic oil HF 24-6  
**Container:** 20 liter HDPE plastic can  
**Power:** 150W (Surface Load 0.05 W/cm<sup>2</sup>)  
**Thermal insulation:** 20mm of NBR-PVC foam, covering the entire cylindrical surface.  
**Insulating lid:** no  
**Insulating base:** no  
**Electronic control:** On-Off with anticipation, with set point set at 60°C  
**Surface temperature:** Limited to 60°C by a safety thermostat.  
**Test conditions:** start at 25°C, stop when the temperature at the center of the tank reaches 50°C  
**Heating time:** 8h 19 min

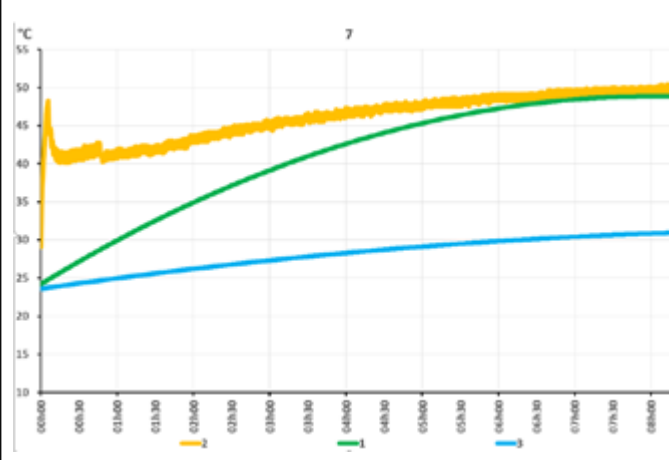
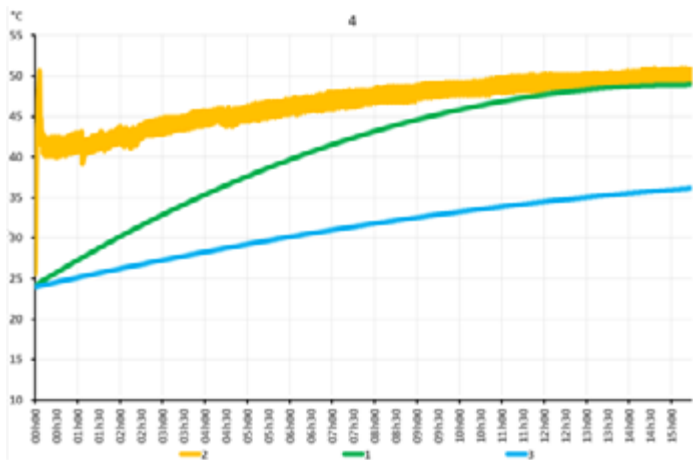

- 1: Temperature of the liquid, at the geometric center of the tank, at half height
- 2: Average temperature, measured at 5 points, of the inner wall of the heating blanket
- 3: Liquid temperature, in the center, 50mm from the bottom

**Fluid:** Water  
**Container:** 60 liter HDPE plastic can  
**Power:** 150W (Surface Load 0.05 W/cm<sup>2</sup>)  
**Thermal insulation:** 20mm of NBR-PVC foam, covering the entire cylindrical surface.  
**Insulating lid:** no  
**Insulating base:** no  
**Electronic control:** On-Off with anticipation, with set point set at 60°C  
**Surface temperature:** Limited to 60°C by a safety thermostat.  
**Test conditions:** start at 25°C, stop when the temperature at the center of the tank reaches 50°C  
**Heating time:** 11h 30 min

**Fluid:** Hydraulic oil HF 24-6  
**Container:** 60 liter HDPE plastic can  
**Power:** 150W (Surface Load 0.05 W/cm<sup>2</sup>)  
**Thermal insulation:** 20mm of NBR-PVC foam, covering the entire cylindrical surface.  
**Insulating lid:** no  
**Insulating base:** no  
**Electronic control:** On-Off with anticipation, with set point set at 60°C  
**Surface temperature:** Limited to 60°C by a safety thermostat.  
**Test conditions:** start at 25°C, stop when the temperature at the center of the tank reaches 50°C  
**Heating time:** 9h 03 min

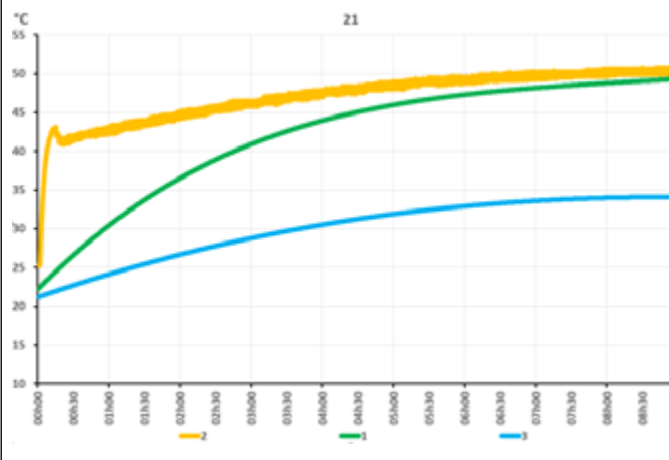
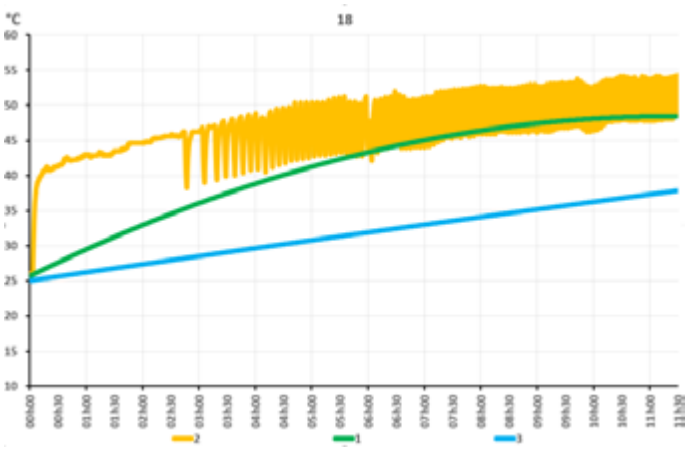

- 1: Temperature of the liquid, at the geometric center of the tank, at half height
- 2: Average temperature, measured at 5 points, of the inner wall of the heating blanket
- 3: Liquid temperature, in the center, 50mm from the bottom

Because of permanent improvement of our products, drawings, descriptions, features used on these data sheets are for guidance only and can be modified without prior advice



## 3-2 With steel containers

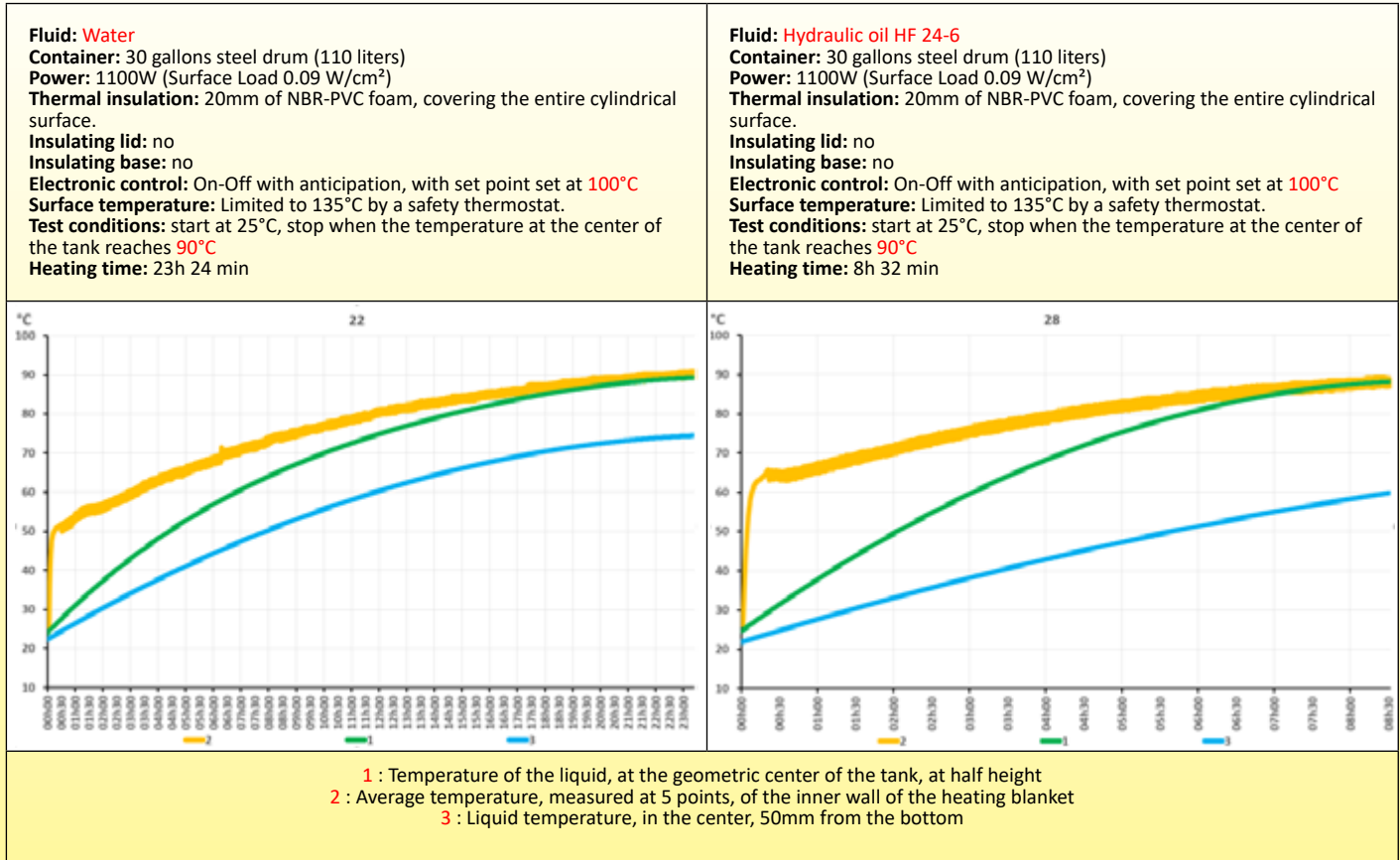

### Incidence of use of thermally insulated lid and bottom

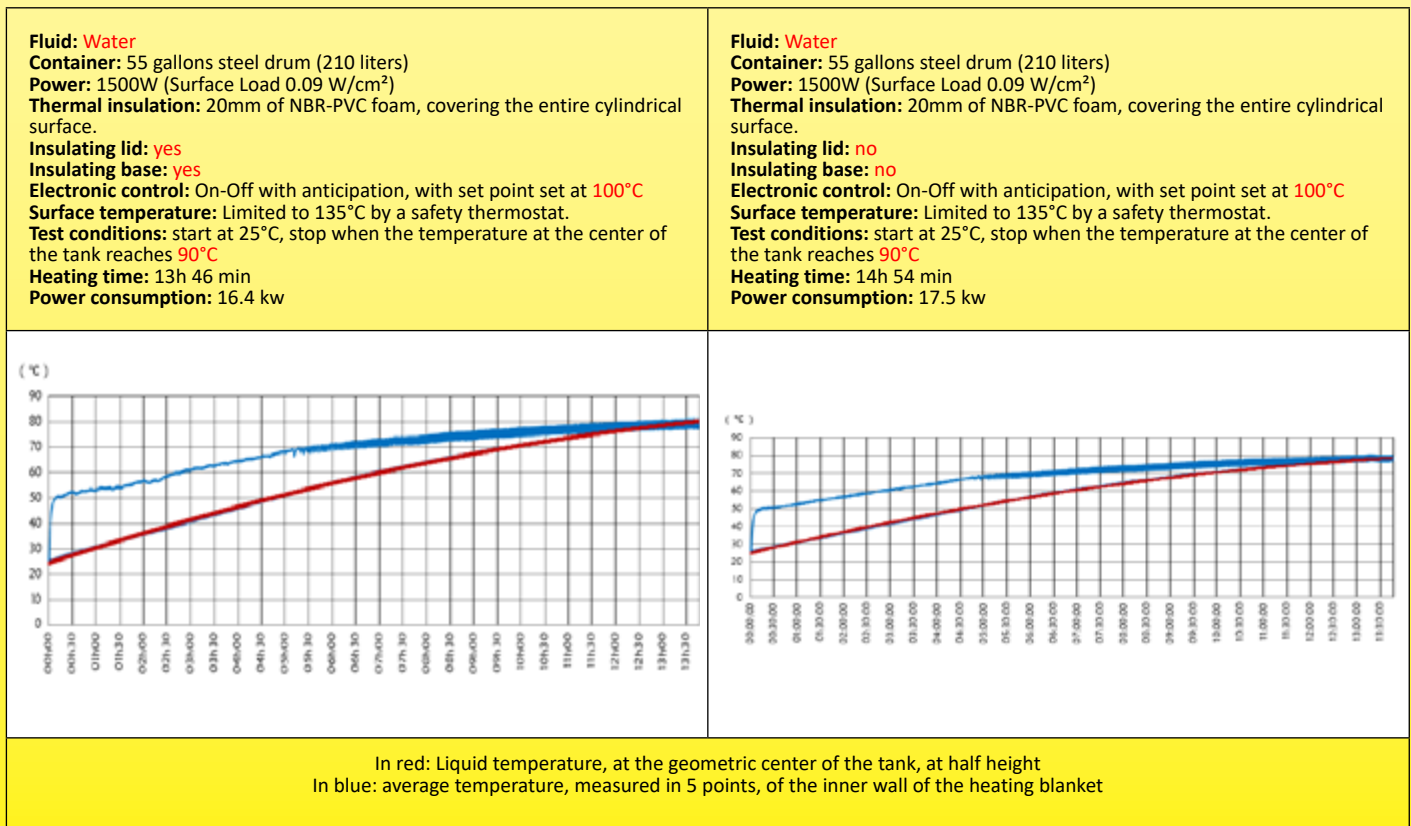

**Analysis of the results :** the use of an insulating pedestal and an insulating lid reduces the heating time by 1h 8 minutes and the consumption by 1.1kw, i.e. 6.3%

Because of permanent improvement of our products, drawings, descriptions, features used on these data sheets are for guidance only and can be modified without prior advice





# Technical introduction

## Differences in heating time between water and oil

**Fluid:** Water  
**Container:** 55 gallons steel drum (210 liters)  
**Power:** 2250W (Surface Load 0.135 W/cm<sup>2</sup>)  
**Thermal insulation:** 20mm of NBR-PVC foam, covering the entire cylindrical surface.  
**Insulating lid:** yes  
**Insulating base:** yes  
**Electronic control:** On-Off with anticipation, with set point set at 120°C  
**Surface temperature:** Limited to 135°C by a safety thermostat.  
**Test conditions:** start at 25°C, stop when the temperature at the center of the tank reaches 95°C  
**Heating time:** 13h 27 min  
**Power consumption:** 23.2 kw

**Fluid:** Hydraulic oil HF 24-6  
**Container:** 55 gallons steel drum (210 liters)  
**Power:** 2250W (Surface Load 0.135 W/cm<sup>2</sup>)  
**Thermal insulation:** 20mm of NBR-PVC foam, covering the entire cylindrical surface.  
**Insulating lid:** yes  
**Insulating base:** yes  
**Electronic control:** On-Off with anticipation, with set point set at 120°C  
**Surface temperature:** Limited to 135°C by a safety thermostat.  
**Test conditions:** start at 25°C, stop when the temperature at the center of the tank reaches 95°C  
**Heating time:** 5h 48 min  
**Power consumption:** 10.5 kw

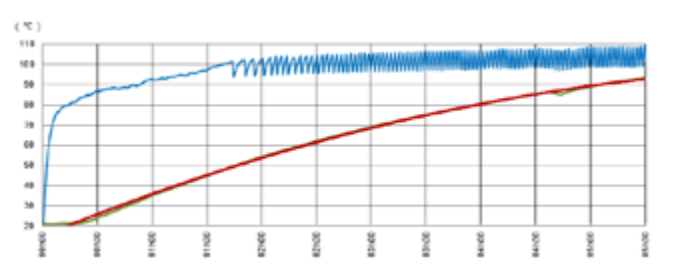
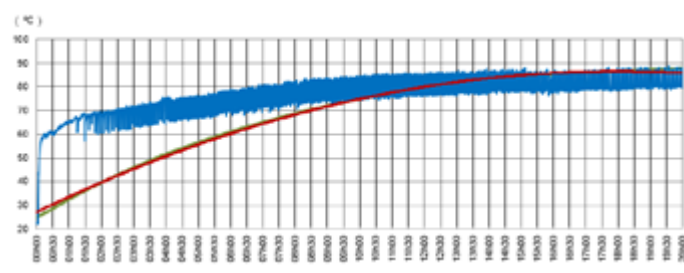

In red: Liquid temperature, at the geometric center of the tank, at half height  
 In blue: average temperature, measured in 5 points, of the inner wall of the heating blanket

**Analysis of results:** under the same conditions of power and adjustment, it takes 807 minutes to heat water and 348 minutes to heat oil, a **ratio of 0.43**. The power consumption is decreased in a **ratio of 0.45**

## Effect of heating power on heating time

**Fluid:** Hydraulic oil HF 24-6  
**Container:** 55 gallons steel drum (210 liters)  
**Power:** 1500W (Surface Load 0.09 W/cm<sup>2</sup>)  
**Thermal insulation:** 20mm of NBR-PVC foam, covering the entire cylindrical surface.  
**Insulating lid:** yes  
**Insulating base:** yes  
**Electronic control:** On-Off with anticipation, with set point set at 120°C  
**Surface temperature:** Limited to 135°C by a safety thermostat.  
**Test conditions:** start at 25°C, stop when the temperature at the center of the tank reaches 108°C and stabilize during one hour  
**Heating time:** 9h 14 min  
**Power consumption:** 11.7 kw

**Fluid:** Hydraulic oil HF 24-6  
**Container:** 55 gallons steel drum (210 liters)  
**Power:** 2250W (Surface Load 0.135 W/cm<sup>2</sup>)  
**Thermal insulation:** 20mm of NBR-PVC foam, covering the entire cylindrical surface.  
**Insulating lid:** yes  
**Insulating base:** yes  
**Electronic control:** On-Off with anticipation, with set point set at 120°C  
**Surface temperature:** Limited to 135°C by a safety thermostat.  
**Test conditions:** start at 25°C, stop when the temperature at the center of the tank reaches 108°C and stabilize during one hour  
**Heating time:** 8h 32 min  
**Power consumption:** 12.7 kw

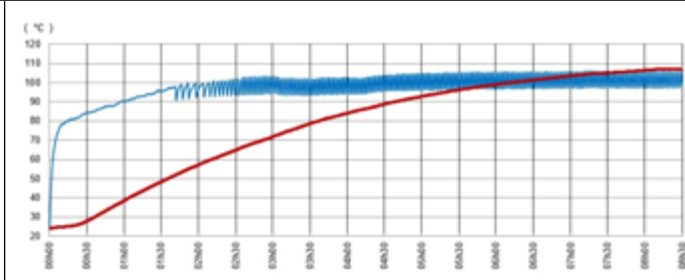
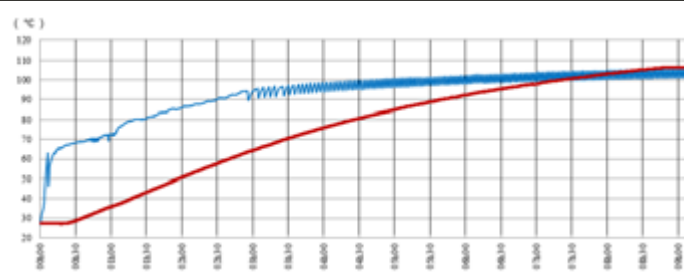

In red: Liquid temperature, at the geometric center of the tank, at half height  
 In blue: average temperature, measured in 5 points, of the inner wall of the heating blanket

**Analysis of results:** increasing the power from 1500 watts to 2250W, being a coefficient of power increase of 1.5, heating time decrease from 554 to 512 minutes to reach the same temperature of 108°C, a **ratio of 0.92**. The power consumption is increased in a ratio of **1.085**.

### 3-3 1000 liters IBC with HDPE reservoir and tubular protective grid in steel

#### Influence of an insulating cover and an insulating base on the heating time of an IBC

The IBCs are particularly long to heat because in addition to the large mass of the container, the jacket heaters are not in direct contact with their wall, because of their protective cage. As a result, the air circulates between the cage and the wall, and the hot air is quickly evacuated from above. We therefore recommend the use of a wraparound lid in addition to the standard hood to block this air circulation. A good insulation of the pedestal, when its placement is possible also significantly reduces the heating time.

Because of permanent improvement of our products, drawings, descriptions, features used on these data sheets are for guidance only and can be modified without prior advice



<p><b>Fluid:</b> Water  <b>Container:</b> 1000 liters HDPE container with tubular frame  <b>Power:</b> 4400W in 2 zones (Surface Load 0.09 W/cm<sup>2</sup>)  <b>Thermal insulation:</b> 20mm of NBR-PVC foam, covering the entire cylindrical surface.  <b>Insulating lid:</b> no  <b>Insulating base:</b> no  <b>Electronic control:</b> On-Off with anticipation, with set point set at 70°C  <b>Surface temperature:</b> Limited to 80°C by a safety thermostat.  <b>Test conditions:</b> start at 25°C, stop when the temperature at the center of the tank reaches 50°C  <b>Heating time:</b> 121h</p>	<p><b>Fluid:</b> Water  <b>Container:</b> 1000 liters HDPE container with tubular frame  <b>Power:</b> 4400W in 2 zones (Surface Load 0.09 W/cm<sup>2</sup>)  <b>Thermal insulation:</b> 20mm of NBR-PVC foam, covering the entire cylindrical surface.  <b>Insulating lid:</b> yes  <b>Insulating base:</b> yes  <b>Electronic control:</b> On-Off with anticipation, with set point set at 70°C  <b>Surface temperature:</b> Limited to 80°C by a safety thermostat.  <b>Test conditions:</b> start at 25°C, stop when the temperature at the center of the tank reaches 50°C  <b>Heating time:</b> 81h 45 min</p>
<p>1 : Temperature of the liquid, at the geometric center of the tank, at half height                  2 : Average temperature of the inner wall of the heating blanket, measured in 16 points                  3 : Liquid temperature, in the center, 50mm from the bottom</p>	

**Analysis of results:** insulation of the lid of a 1000-liter IBC makes it possible to reduce the heating time from 121 hours to 81.45 hours, a **very important saving of time**, with a **ratio of 0.67**

## Incidence of stirrer on heating time

The use of a stirrer, circulating a cooler liquid on the walls increases the heat exchange. Insulating lid and pedestal allow full use of heat produced.

<p><b>Fluid:</b> Water  <b>Container:</b> 1000 liters HDPE container with tubular frame  <b>Power:</b> 4400W in 2 zones, surface Load 0.09 W/cm<sup>2</sup>  <b>Thermal insulation:</b> 20mm of NBR-PVC foam, covering the entire cylindrical surface.  <b>Insulating lid:</b> yes  <b>Insulating base:</b> yes  <b>Stirrer:</b> yes  <b>Electronic control:</b> On-Off with anticipation, with set point set at 70°C  <b>Surface temperature:</b> Limited to 80°C by a safety thermostat.  <b>Test conditions:</b> start at 25°C, stop when the temperature at the center of the tank reaches 50°C  <b>Heating time:</b> 36h</p>	<p><b>Fluid:</b> Water  <b>Container:</b> 1000 liters HDPE container with tubular frame  <b>Power:</b> 4400W in 2 zones (Surface Load 0.09 W/cm<sup>2</sup>)  <b>Thermal insulation:</b> 20mm of NBR-PVC foam, covering the entire cylindrical surface.  <b>Insulating lid:</b> yes  <b>Insulating base:</b> yes  <b>Stirrer:</b> no  <b>Electronic control:</b> On-Off with anticipation, with set point set at 70°C  <b>Surface temperature:</b> Limited to 80°C by a safety thermostat.  <b>Test conditions:</b> start at 25°C, stop when the temperature at the center of the tank reaches 50°C  <b>Heating time:</b> 81h 45 min</p>
<p>1 : Temperature of the liquid, at the geometric center of the tank, at half height                  2 : Average temperature of the inner wall of the heating blanket, measured in 16 points                  3 : Liquid temperature, in the center, 50mm from the bottom</p>	

**Analysis of the results:** The addition of an insulating pedestal and a stirrer greatly reduces the heating time, since one goes from 81h 45 minutes to 36h, a **remarkable ratio of 0.44**. Compared to the model without insulating cover, this time goes from 121h to 36h, an **extraordinary ratio of 0.3**. We can only recommend the use of these accessories.



## 4. Comparison of heating times required for different liquids currently heated by jacket heaters and electric blankets



Testing equipment

In order to give an idea to the users heating specific products, we carried out, under identical test conditions, comparative tests by recording the necessary time and the evolution of the temperature during the heating of a liter of product, from 20°C to 90°C (measured at the geometric center of the tank).

These tests were made with two different values of surface power load: 0.1W/cm<sup>2</sup>, as it is an usual value of industrial electric jacket heaters, and 0.4W/cm<sup>2</sup>, which is maximum value achievable in this type of device.

**Test conditions:** Heating performed in a cylindrical tank diameter 76mm height 280mm, flat bottom, red copper 2mm thick, the entire cylindrical portion filled with the product (250mm) is heated by a flexible silicone heater, insulated with 20mm of PVC-NBR foam. The heating is made without temperature control or safety temperature limiter. The ambient temperature is maintained at 20°C. in a climatic chamber. The test is stopped when the temperature at the center of the product has reached 90°C.

Characteristics of the products used in the tests

Products	Thermal conductivity W/m.K	Specific heat capacity (kJ/kg.K)	Kinematic viscosity at 20°C mm <sup>2</sup> /s	Specific gravity Kg/m <sup>3</sup>
Water	0.597@20°C	4.182	1.006@20°C	0.998@20°C
Olive oil	0.189@15°C	1.25	91.5@20°C	0.922 @20°C
Lard	0.407@25°C	2.1	Frozen (melting between 35 and 42°C)	0.924-0.930
Mineral oil ISO VG680	0.134@40°C	1.99	4000@20°C	0.850
Butter	0.197 @46°C	2.3	Frozen (melting between 27 and 32°C)	0.87-0.93

With a surface load of 0.1W/cm<sup>2</sup> (60W)

With a surface load of 0.4W/cm<sup>2</sup> (240W)

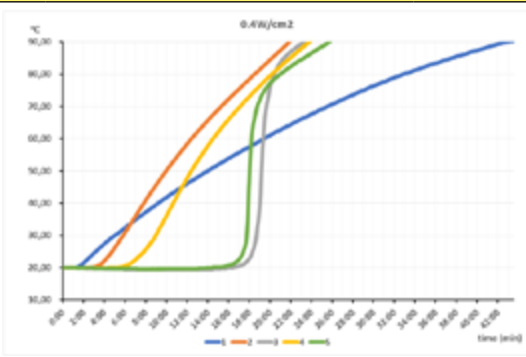
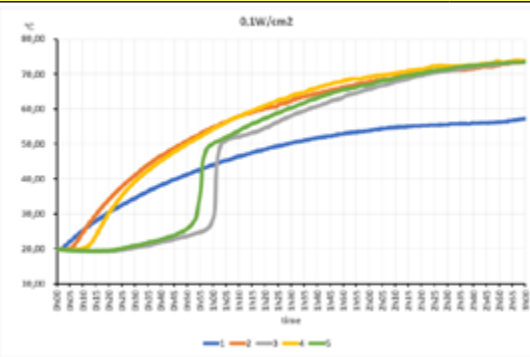

1: Water; 2: Olive oil; 3: Lard; 4: ISO VG680 Mineral oil; 5: Butter

**Analysis of the results:** The water, with a heating capacity of 2 to 4 times greater than the other products, thus requires more energy to warm up and thus heats up much less quickly. Products frozen at room temperature (butter, animal fat) retain for a long time a central cold part for lack of convection currents, before quickly reaching the temperature of the other oils when they liquefy.



## 5. Energy balance

To heat from 25 to 80°C a barrel of 55 gallons (220 Liters), with a 1500W electric heater, the theoretical calculation without heat losses gives a duration of 9 hours 23 minutes and a consumption of 14 kw.

In the real energy balance, the losses to the external environment, which depend on the quality of the thermal insulation, are involved. In the case of our tests, insulation is made by a NBR-PVC foam with an insulation coefficient  $\leq 0.036 \text{ w/m.k}$ .

For 55 gallons drum (220l) with thermal insulation on all sides, an average total consumption of 16 to 17 kw is measured for reheating water. The energy yield is then around 88%.

Under the same conditions, the measured times range from 13 hours 45 minutes to 14 hours. This is **1.5 time** the theoretical time.

The heating time is extended by the heat transfer conditions between the blanket and the product to be heated and by the homogenization of the temperature in the container, which can be very long to take place, because temperature differences between the bottom and the upper part can reach 25 to 30°C during the heating period. A temperature homogenization system such as a stirrer will therefore reduce the heating time, but its power consumption will add to that of the heating.



# Technical introduction

## Second part : Construction features and performance validation

### 1. IP tests (Resistance to water ingress)

Protection against water ingress is an essential parameter of industrial heating blankets and jacket heaters, which may be subject to overflows and various projections. Everything in the design of these devices has been implemented to continue to ensure the protection of users in the harshest conditions. In the heating part, the electrical connections between heating cables, connecting conductors, thermostats, limiters, connectors and other components are sealed and meet the IP66 classification. Control and connection boxes, accessible by users, are IP69K. However, although the fabrics used are waterproof, although the zippers are watertight, limited water penetration into the heating zone can occur, most often through seams. All the inner wiring of this part being waterproof, this penetration of water does not question the electrical insulation of the devices.



IPx6 testing of jacket heaters



Insulation resistance measurement after IPx6 tests

### 2. Thermal safety and temperature limiter. Maximum wall temperature and use on empty containers.

One of the conditions of critical use of industrial flexible heating blankets is related to their use on containers full, but also partially or totally empty. When the temperature limiter is in contact with a wall behind which there is no more liquid, or when it is not in contact with a surface with which the heating blanket can exchange its calories, it must react to overheating of heating elements. For this reason, it is in contact with them thanks to two heating wire loops, via a patented flexible thermal semiconductor. This system then switches off the heating when the local temperature becomes too high, and then limits the amount of energy supplied to the heating elements.

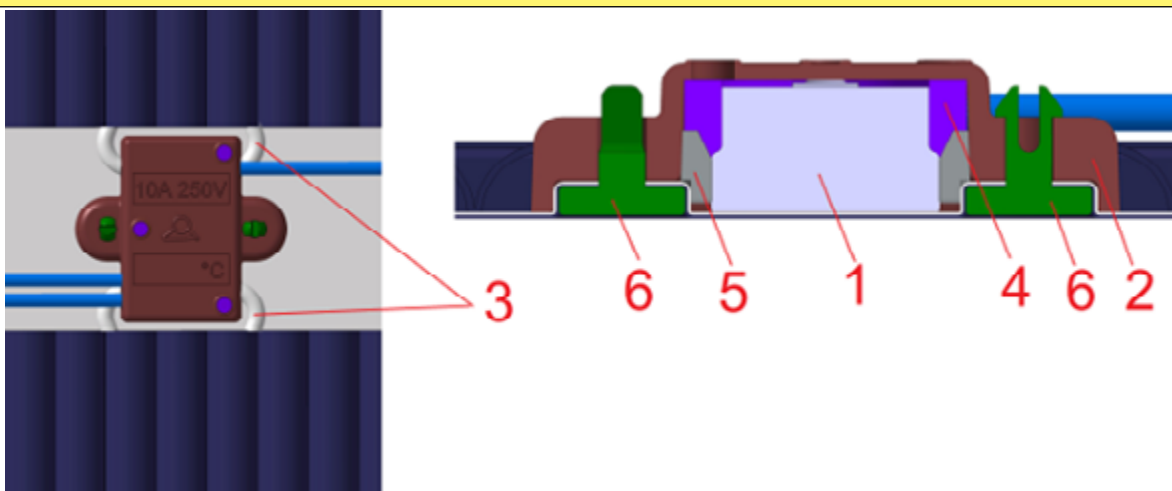

- 1 : Limiter
- 2 : PA66 enclosure
- 3 : Heating wire loops
- 4 : Resin filling
- 5 : Thermal semiconductor
- 6 : Clips for fabric surface mounting

Because of permanent improvement of our products, drawings, descriptions, features used on these data sheets are for guidance only and can be modified without prior advice



### 3. Tests for permanent and peak temperature insulation of the insulating foam, measurement of the retraction rate after heating, tests for water recovery after heating.



The selection of an effective thermal insulation over the range of temperature of the blanket and jacket heaters eliminates most of the flexible thermal insulation available on the market:

- The glass wool, rock wool, ceramic wool, because of their permeability and their «sponge» effect
- Polyurethane and polyethylene foams because of their flammability and poor temperature behavior
- The carbon fiber felts because of their inflammability and their «sponge» effect
- NBR and NR foams because of their flammability.
- Silicone foams because of their prohibitive price.

From intensive tests made on these different materials, only the PVC-NBR foam appeared adapted to the use. It combines the insulating effect of closed-cell NBR foam (thus without sponge effect) with the self-extinguishing properties of PVC.

For these tests, the foam is placed around a heating barrel set at 120°C (maximum permanent temperature of the heating blanket), for 96 hours. After this period, the variation of its insulating power, and its size change (elongation or shortening) are measured, then its porosity is evaluated by weighing after immersion in water for 8 days.

Another test is also performed, the verification of the peak temperature resistance. Subjected at 300°C for 30 minutes, the PVC-NBR foam does not ignite, but loses its flexibility and cracks.

However, higher temperatures, impossible to achieve in normal operation, initiated by the supply of energy external to the process, can initiate the slow combustion of the foam

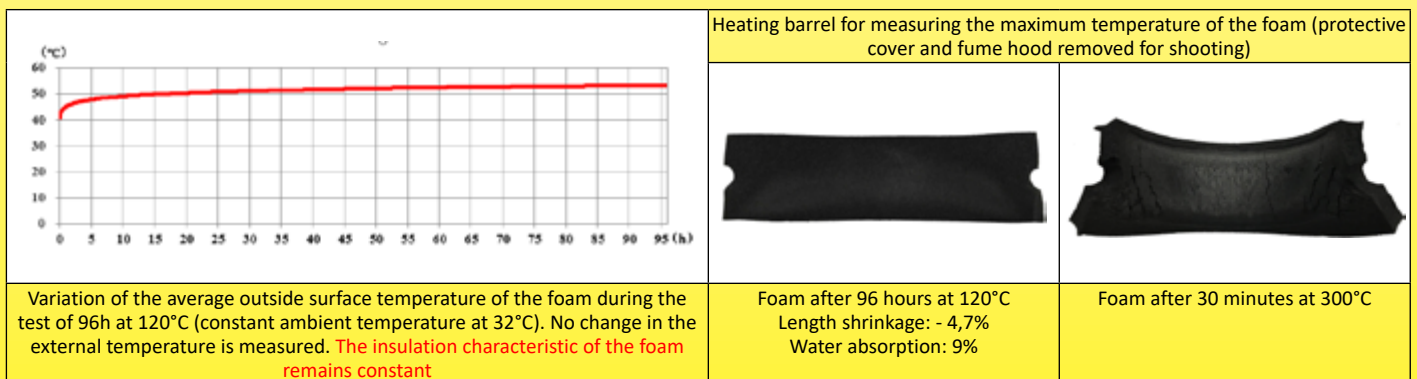

### 4. Search for hot spots in heating cables

During the manufacture of the heating conductors, it happens that splices are made to butt the conductors when changing wire coils. These splices are then taken up under the silicone insulation, they remain invisible. But a poorly executed splice may add additional electrical resistance to the heating cable where it is made. This type of fault then causes a hot spot. This hot spot is detected by thermal imaging during the final test of the cover. An additional X-ray hot spot check then verifies the cause of the fault and replace the heating cable prior to use.

Because of permanent improvement of our products, drawings, descriptions, features used on these data sheets are for guidance only and can be modified without prior advice



Because of permanent improvement of our products, drawings, descriptions, features used on these data sheets are for guidance only and can be modified without prior advice

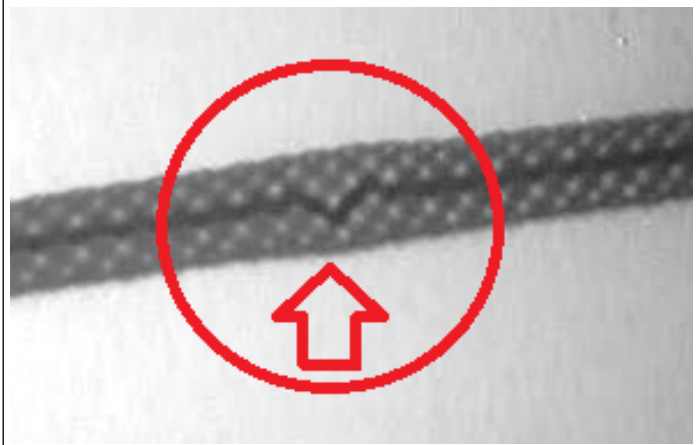
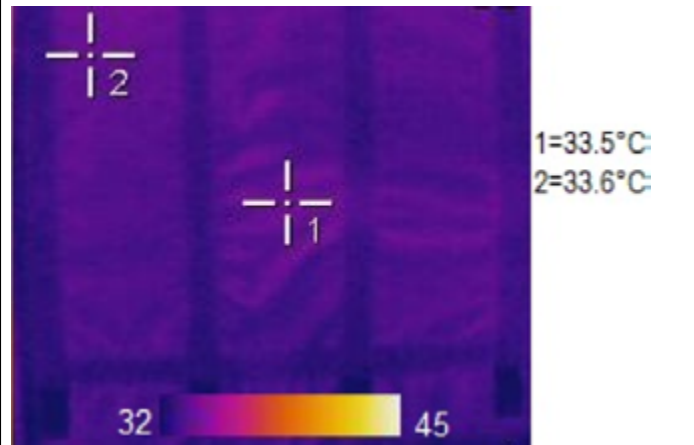
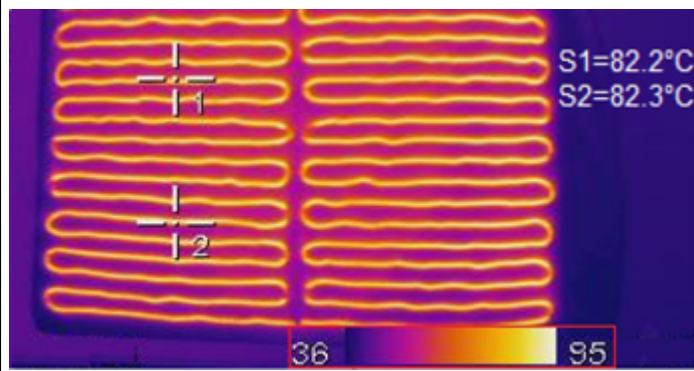

Examples of thermal imaging of a heating blanket. Top photo taken on the inside, heated side, and photo of the underside, non-heated outside (ambient temperature 32°C)

Detection of connection faults or hot spots of X-ray heating wires (protective screen removed for shooting). Example of hot spot detected: splice between the heating conductors.

## 5. Surface temperature of heating wires for a heating blanket without contact with a wall, as a function of the watt-density

Apart from any temperature control, a heating wire embedded inside a blanket heater or a jacket heater will reach, in a calm air without mechanical ventilation, a stabilizing temperature depending on its external surface and its power.

The design of an industrial blanket heater or jacket heater must take into account this factor so that the temperature reached in the worst operating conditions can not destroy or melt the fabric of the structure, and retains an electrical insulation **guaranteeing the safety of the people, including when two heating layers are superimposed or when it is not in contact with the surface of the container.**

It is by using heating wires with **low surface watt density**, by using a heating net with **compact heating wires pitch**, that the temperature of the surface of the heating blanket will be more homogeneous, without hot spots. In the most common models (220 liters drum, 1000 liters IBC), this results in significant lengths of heating wire from 80 to 160 meters per device. But it is the sine-qua-non condition of **reliable** professional devices.

The surface watt density values of the heating blankets are divided into 4 classes, depending on the types of containers used and the maximum temperature that can be reached in the container.

- **Low temperature class:** 0.05W/cm<sup>2</sup>. This class allows the heating of plastic tanks, for example polyethylene. The maximum temperature reached by the heating cable, without temperature control, is 50°C. This is the most common solution for antifreeze applications.

- **Middle temperature class:** 0.095W to 0.1W/cm<sup>2</sup>. This class allows the heating of metal containers containing water or a liquid not to exceed 80°C. The maximum temperature reached by the heating cable, without temperature control, is 85°C

- **High temperature class:** 0.135W/cm<sup>2</sup>. This class allows the heating of metal containers containing a liquid not to exceed 110°C. The maximum temperature reached by the heating cable, without temperature control, is 110°C

- **Very high temperature class:** 0.25W/cm<sup>2</sup>. This class allows the heating of metal containers containing a liquid not to exceed 150°C. The maximum temperature reached by the heating cable, without temperature control, is 160°C. This particular class requires enhanced thermal protection of fiberglass and kapton heating cables. Control systems mounted on the surface of the cover are not possible, and PID control with Pt100 sensor and remote mounting box is the only possible temperature control.



Equipment for measuring the surface temperature as a function of the surface  $W/cm^2$  of the blanket heater or jacket heater

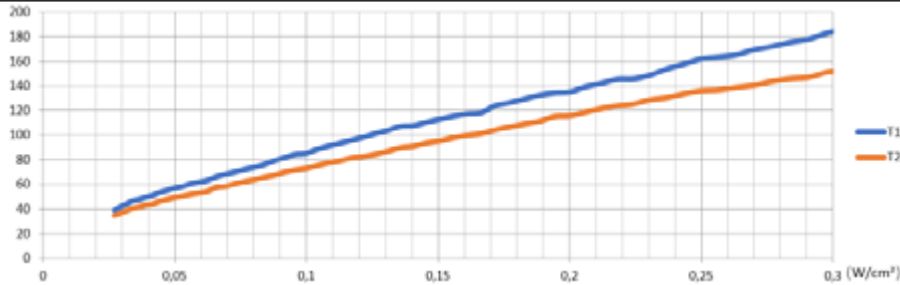

Surface temperature, in °C, in an environment at 20°C, of heating wires with metal protection braiding, for different surface watt density values of the heating blanket or jacket heater.  
 T1 = surface temperature of the heating wire.  
 T2 = outer surface temperature of the blanket or jacket.

## Deterioration of the surface as a function of the temperature reached on the heating wires, for blankets or jackets heaters with wires embedded under PA66 fabric with PTFE protective film (Standard low, medium and high temperature versions)

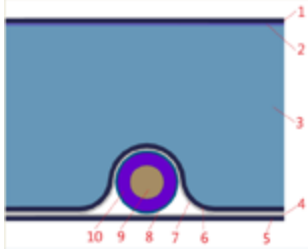

Cut view of the heating cord embedded between the flexible walls (standard version)

- 1, 5, 6: High resistance polyamide fabric
- 2: Polyurethane sealing layer of the outer polyamide fabric
- 3: Insulating PVC-NBR foam
- 4, 7: PTFE film (overheating protection)
- 8: Tinned brass braid (mechanical protection and grounding)
- 9: Heating wire
- 10: Silicone insulation 300V, thickness 1.1mm



96 hours at 120°C on the heating cable: no color change, no insulation melting, no change in characteristics

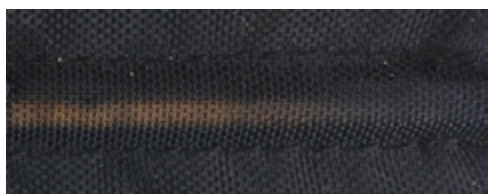

1h at 220°C on the heating cable: the PA66 starts to change color



1h at 235°C on the heating cable: The PA66 begins to melt



5 minutes at 245°C on the heating cable, the PA66 has melted, and reveals the protective layer of PTFE which is not deteriorated. The protection of the heating cord is always done by PTFE and silicone insulation.







# Technical introduction

Because of permanent improvement of our products, drawings, descriptions, features used on these data sheets are for guidance only and can be modified without prior advice

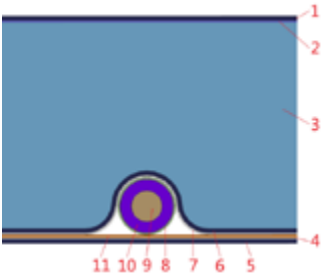
Deterioration of the surface as a function of the temperature reached on the heating cord, for covers with heating elements **mounted on fiberglass fabric and Kapton film**, and covered under PA66 fabric with PTFE protective film (**very high temperature version**).

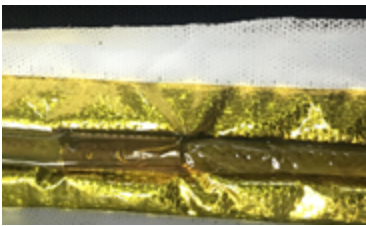
	<p>Cut view of the heating cord embedded between the flexible walls</p> <ol style="list-style-type: none"> <li>1: High resistance polyamide fabric</li> <li>2: Polyurethane sealing layer of the outer polyamide fabric</li> <li>3: Insulating PVC-NBR foam</li> <li>4: PTFE film (overheating protection)</li> <li>5: High resistance polyamide fabric</li> <li>6: Non-combustible fiberglass fabric</li> <li>7: heat reflective aluminium film</li> <li>8: Tinned brass braid (mechanical protection and grounding)</li> <li>9: Heating wire</li> <li>10: Silicone insulation 300V, thickness 1.1mm</li> <li>11: Additional thermal protection and electrical insulation by kapton film</li> </ol>
	<p>5 minutes at 250°C on the heating cable, the external temperature at the PA66 fabric layer causes its color change</p>
	<p>5 minutes at 320°C on the heating cable, the external temperature at the PA66 fabric layer causes its melting</p>
	<p>5 minutes at 350°C on the heating cable, when opening of blanket heater, we can see that the holding and insulation to the outside of the heating cable is still provided by fiberglass and Kapton. A further increase in temperature causes deterioration of the silicone sheath of the cord, and puts its live parts in contact with the metal braid which then switch off the power supply, without an electrical loss to the outside is possible.</p>

## 6. Insulation resistance and breakdown voltage

The insulation resistance decreases with the length of heating wire used. If this length can go down to a few meters in the small heating blankets and jacket heaters, it can exceed more than 160 meters on the 1000 liters IBC jackets heaters.

In production, the insulation values are 100% measured at ambient temperature. Our minimum acceptance limit for any condition (dry, hot, or after IP65 test) is 0.1Gohms (100x the limit of EN60335-2-17§ 19.112.3).

This measurement is carried out with the heater sandwiched between two metal sheets covering the entire surface and pressed against each other with a load of 35 DaN/m<sup>2</sup>.

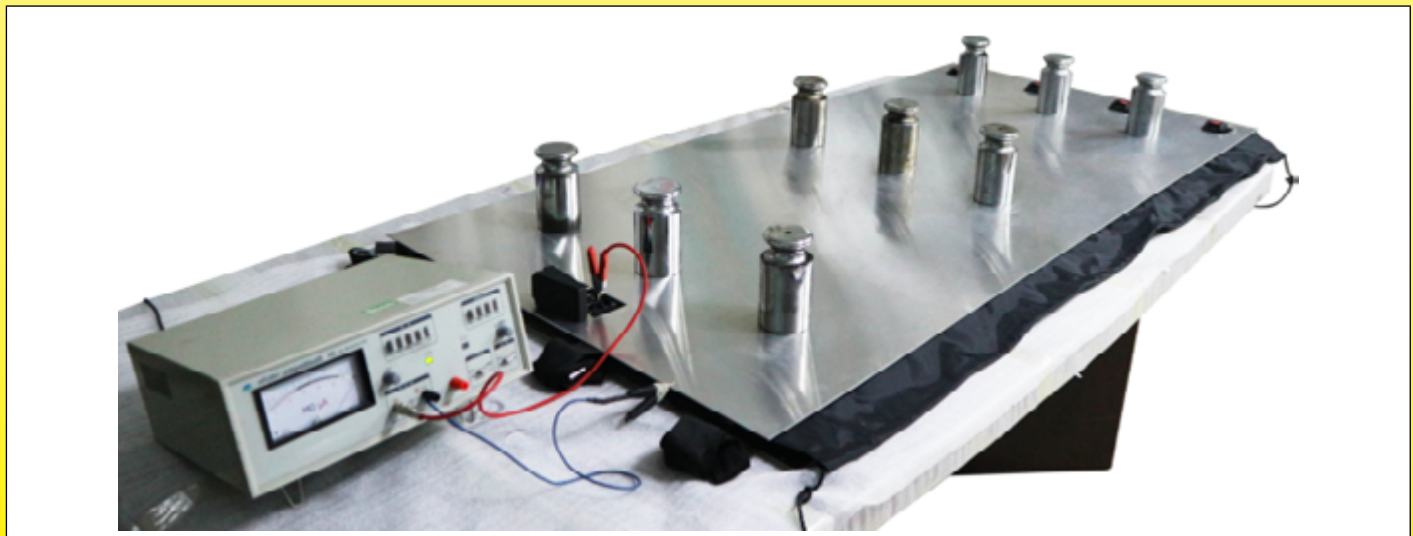

Device for measuring the insulation resistance.  
The measured values are always greater than 0.1Gohm

## Electric strength at cold conditions

In all protected heating elements, there is a leakage current passing through their insulation. This leakage current increases with the applied voltage.

In the case of heating blankets, a production test for measuring the **total leakage current** is performed by placing the heater between two metal plates and applying a voltage of 1750 volts between the conductors and the metal plates according to 60-335-2 -17 § 22.115. In application of the EN60519-1 standard, the maximum leakage current allowed during **1 minute** is a function of the nominal ampacity of the jacket or blanket heater, it is 3mA for ampacities less than 7A (1600W in 230V) and 0.5mA per ampere for higher currents (eg 10mA for 2000W, 15mA for 3000W). For 1000 liter IBC heaters with 2 independent heating zones, this measurement is performed independently for each zone.

The large value of the leakage current on the large dimensions jacket heaters requires their connection to a power supply circuit protected by a differential circuit breaker calibrated at 20mA.

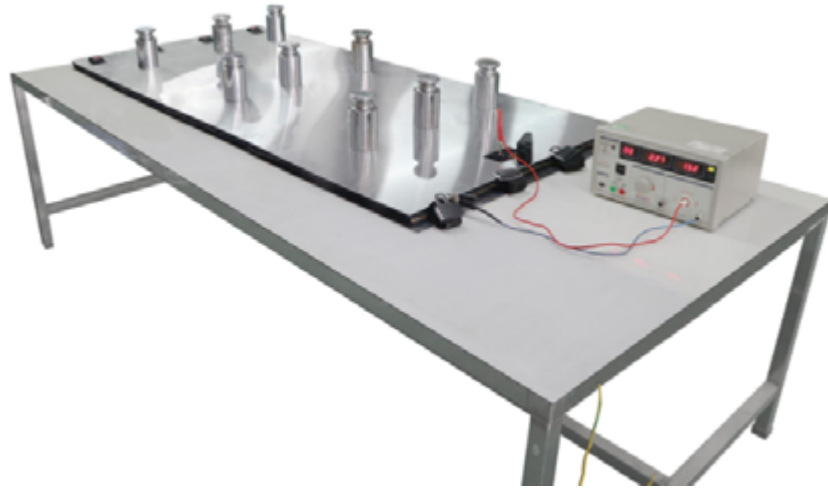

Measuring equipment for total current leakage at cold condition

## Leakage current at operating temperature

Leakage current measurement on hot and accessible surfaces is a parameter intended to verify the safety of an appliance to avoid electric shock when touched while it is in operation. **This is a way to check that its electrical insulation does not degrade and remains sufficient when the operating temperature is reached.** The tests consist, in accordance with the articles of standards EN60335-1-13.1 and 13.2, to place a metal plate of 10 x 20 cm (simulating the size of a hand) on the blanket or jacket heater, and to measure the current passing between this plate and the live conductors when the heating blanket has reached its maximum temperature. The maximum limit value is 0.75mA at 240V. Our tests are validated by an average value of 6 measurements made at different locations, under a power equal to 1.15 times the nominal power.



Measuring equipment for total current leakage at hot condition



## 7. Tightening and holding systems for jacket heaters on tanks

**Holding and tightening the jacket heaters on the containers is an important parameter in the regularity of heating. It is therefore important to use the best way to ensure the best heat transfer at all temperatures. For this different means are implemented:**

- **Velcro tape tightening:** easy to use and economical, it does not withstand high temperatures and its regular use deteriorates when external contaminants clog the tape. Adjustment of the tightening is impossible after pressing the 2 bands on each other.

Breaking load at room temperature on 50mm wide strips, with 100mm contact between the two hanging parts: 26 DaN

Breaking load at high temperature under load of 15 DaN: 120°C

Withstand 15 DaN load without breaking at -50°C

- **Plastic snap buckles:** economic, but not resistant in temperature, and their opening can happen unexpectedly when the tightening force is too important.

Breaking load at room temperature: 44 DaN

Breaking temperature under 15 DaN load: 100°C

Withstand 15 DaN load without breaking at -50°C





- **The «automotive» type metal safety buckles:** they are more expensive than plastic buckles, they resist very well to temperature, they allow a great tightening even after their closing, and they are easy and quick to open.

Breaking load at room temperature: 240 DaN

Breaking temperature under load of 15 DaN: withstands 150°C without breaking

Withstand 15 DaN load without breaking at -50°C

- **Scarf:** Sewn on the upper part of the jacket heater, it is intended to be tightened above the container, or around the neck of the bucket or the carboy. It prevents the jacket heater from slipping down. It also serves to keep the insulation lid in place when used, and limits heat loss upward by blocking airflow. It is the indispensable complement of the clamping systems.

Velcro	Plastic snap buckles	Metal « Automotive » buckles	Scarf
			

## 8. Fabrics tear strenght

The fabrics chosen for industrial blankets and jacket heaters were selected to provide exceptional tear resistance. This resistance is tested on laser cut specimens with dimensions in accordance with EN 60335-2-17§21.110.1. Depending on their location and the type of covers, their resistance ranges from 44N to 107N (4 to 9 times the value of 12.5N required)





## 9. Minimum power for use in anti-freeze protection

In many applications, jacket heaters are used to prevent containers from freezing. But the information given by the different manufacturers is often inaccurate or incorrect.

We conducted systematic climate chamber tests to determine the surface power in  $W/cm^2$  required to prevent a container from freezing as a function of ambient temperature.

These tests were carried out on fully insulated tanks (sides, bottom, lid) by heating blankets with insulating walls of 10 or 20mm. The set point of the on-off electronic temperature controller for heating the cover is set to  $5^{\circ}C$  and the differential set to  $2^{\circ}C$

Because of permanent improvement of our products, drawings, descriptions, features used on these data sheets are for guidance only and can be modified without prior advice



Climate chamber, with temperature adjustment range from  $-90$  to  $+150^{\circ}C$ , relative humidity adjustment range 1 to 100%



Jacket heaters during climate tests in negative temperatures

### Tests with 10mm insulation foam thickness

(In blue the temperature of the liquid in the center of the tank. In red the wall temperature of the tank under the insulation)

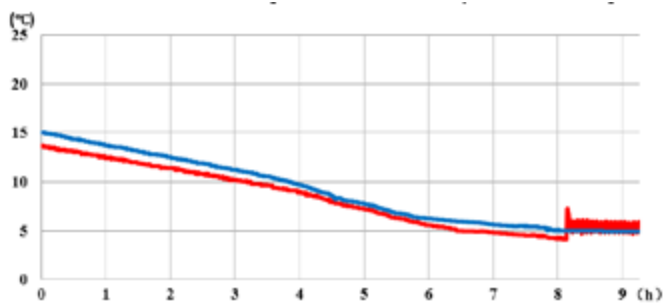

Variation of the water temperature in the container, while the ambient temperature is  $-10^{\circ}C$ , with a surface load of  $0.05 W/cm^2$  (150W). It can be seen that the internal temperature of the container stabilizes at  $5^{\circ}C$ .

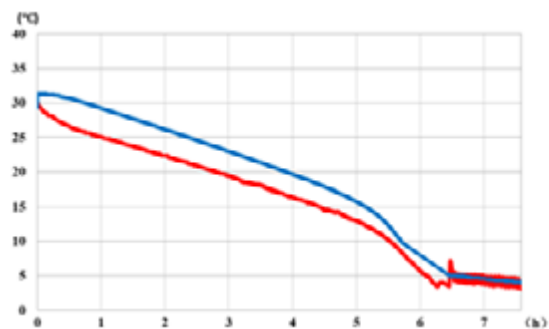

Variation of the water temperature in the container, while the ambient temperature is  $-35^{\circ}C$ , with a surface load of  $0.1 W/cm^2$  (300W). It can be seen that despite the increased heating power, the internal temperature of the tank continues to fall slowly



## Tests with 20mm insulation foam thickness

(In blue the temperature of the liquid in the center of the tank. In red the wall temperature of the tank under the insulation)

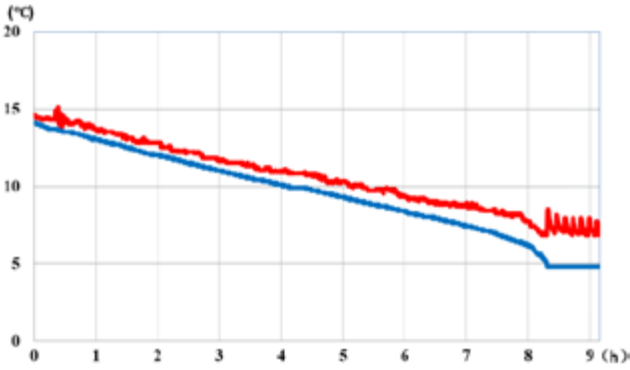

Variation of the water temperature in the container, while the ambient temperature is  $-10^{\circ}\text{C}$ , with a surface load of  $0.05\text{ W/cm}^2$  (150W)  
It can be seen that the internal temperature of the container stabilizes at  $5^{\circ}\text{C}$ .

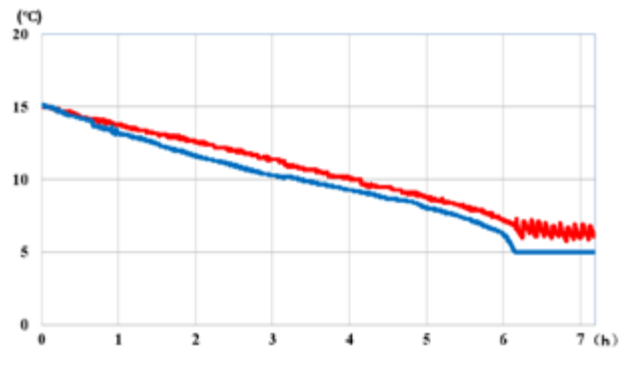

Variation of the water temperature in the container, while the ambient temperature is  $-15^{\circ}\text{C}$ , with a surface load of  $0.05\text{ W/cm}^2$  (150W)  
It can be seen that the internal temperature of the container stabilizes at  $5^{\circ}\text{C}$ .

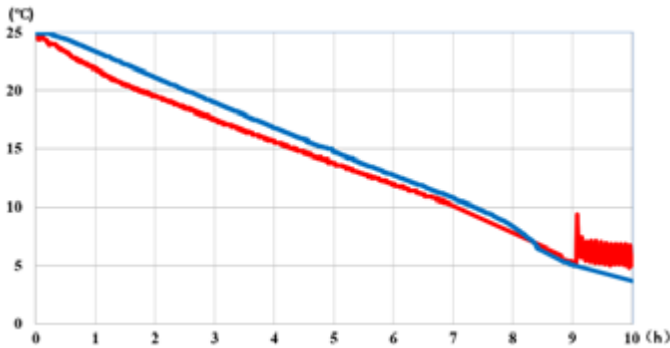

Variation of the water temperature in the container, while the ambient temperature is  $-20^{\circ}\text{C}$ , with a surface load of  $0.05\text{ W/cm}^2$  (150W)  
It can be seen that the internal temperature of the tank continues to drop sharply

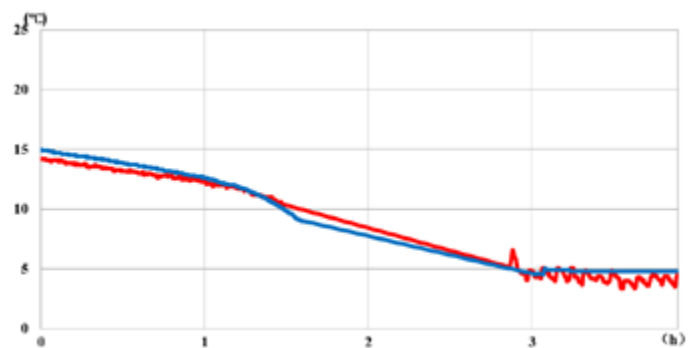

Variation of the water temperature in the container, while the ambient temperature is  $-35^{\circ}\text{C}$ , with a surface load of  $0.1\text{ W/cm}^2$  (150W)  
It can be seen that the power increase allows to stabilize the internal temperature of the container at  $5^{\circ}\text{C}$ .

**Analysis of the results:** With an insulation thickness of 10mm on all sides, the surface charge of  $0.05\text{ W/cm}^2$  is sufficient to protect against freezing an insulated tank up to ambient temperatures of  $-10^{\circ}\text{C}$ . By increasing the surface load up to  $0.1\text{ W/cm}^2$  the protection exists up to  $-15^{\circ}\text{C}$ .

With an insulation thickness of 20mm on all sides, the surface load of  $0.05\text{ W/cm}^2$  is sufficient to protect an insulated tank from freezing up to ambient temperatures of  $-15^{\circ}\text{C}$ . By increasing the surface load up to 0.09 to  $0.1\text{ W/cm}^2$  the protection exists up to  $-35^{\circ}\text{C}$ .

## 10. Temperature controls

All jacket and blanket heaters use the same waterproof connector on their control module. This connector exists for 10 or 20mm thickness of thermal insulation. The earth connection is realized, as well as the earthing of the container when it is metallic.





<p>Simplified connection box, for fixed temperature jacket and blanket heaters. The surface temperature measurement is then performed by a bimetal limiter embedded in the heating wires network. Power supply "on" and heating "on" are displayed by 2 pilot lights. <b>This control box version is not interchangeable with models of blanket or jacket heaters with built-in NTC sensor, intended for electronic control.</b></p>	
<p>Fixed temperature mechanical room thermostat incorporated in the cover of the connection box. Automatic activation of the heating when the temperature drops below 5°C, with pilot lights indicating power on and heating on. <b>This control box version is not interchangeable with models of blanket or jacket heaters with built-in NTC sensor, intended for electronic control.</b></p>	
<p>Electronic thermostat for NTC sensor. On-Off action with anticipation, adjustment by knob, with pilot lights indicating power on and heating on. Mounting on the blanket heater or jacket heater connector. Temperature control according to the container wall temperature.</p>	
<p>Electronic thermostat for NTC sensor. On-Off action with anticipation, digital display. Direct mounting on the jacket or blanket heater connector. Temperature control according to the container wall temperature</p>	

Because of permanent improvement of our products, drawings, descriptions, features used on these data sheets are for guidance only and can be modified without prior advice



Because of permanent improvement of our products, drawings, descriptions, features used on these data sheets are for guidance only and can be modified without prior advice

Electronic thermostat for NTC sensor. On-Off action with anticipation, digital display. Remote control with connection by cable on the jacket or blanket heater connector. Temperature control according to the container wall temperature



Electronic thermostat for NTC sensor. On-Off action, digital display. Remote wall mounting. Features a long temperature sensing probe for immersion in the liquid. Can be used in addition to surface temperature control, to end the reheating process when the core temperature of the liquid is reached.  
**Attention: it cannot be used directly for the control of the heating, without it already exists a regulation of surface temperature, because it does not replace it.**

Also available with Pt100 temperature sensor.





Electronic temperature controller, Pt100 sensor input, autotune PID action. Dual digital display: measured temperature and set point value. Temperature control according to the container wall temperature. Available only with remote control box. **This version, using a Pt100 type sensor is not interchangeable with the models of blanket and jacket heaters with built-in NTC sensor**



## Rohs, Reach

**Rohs:** The materials used in the jacket heaters comply with the European directive 2015/863 Annex II amending Directive 2011/65.

These tests are part of the standard quality control at Ultimheat, and are performed systematically for the validation of each supplier's delivery.

They are made in our own laboratory, with latest-generation measuring instruments.

If desired, we can provide certificates made by an approved external laboratory.

**Reach:** The materials used in the jacket heaters comply with the REACH European Directives according to the June 2017 directive adding 173 substances SVHC (Substances of Very High Concern) from the list published by ECHA on 12 January 2017, applying to the Reach directive 1907/2006.

Certificates made by an accredited external laboratory available on request.

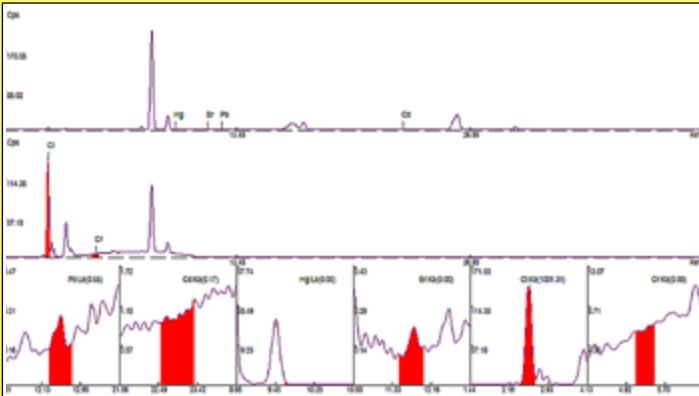

Rohs spectrogram of a NBR-PVC insulation foam sheet (Ultimheat laboratory)



Spectrometric analysis in progress (Ultimheat Laboratory)

Because of permanent improvement of our products, drawings, descriptions, features used on these data sheets are for guidance only and can be modified without prior advice





# References list



Because of permanent improvement of our products, drawings, descriptions, features used on these data sheets are for guidance only and can be modified without prior advice



# References list

Because of permanent improvement of our products, drawings, descriptions, features used on these data sheets are for guidance only and can be modified without prior advice

Reference
9VJ32300958150HC
9VJ32301028165HC
9VJ32401398275HG
9VJ32731558550HG
9VJ32300958300HC
9VJ32301028330HC
9VJ32401398550HG
9VJ32731558A10HG
9VJ22731558550HG
9VJ22881898880HG
9VJ22A04398B205G
9VJ22731558A10HG
9VJ22881898A66HG
9VJV6300958150HC
9VJV6301028165HC
9VJV6401398275HG
9VJV6731558550HG
9VJV6300958300HC
9VJV6301028330HC
9VJV6401398550HG
9VJV6731558A10HG
9VJF6731558550HG
9VJF6881898880HG
9VJF6A0D398B205G
9VJF6731558A10HG
9VJF6881898550HG
9VJMA300958150HC
9VJMA301028165HC
9VJMA401398275HG
9VJMA731558550HG
9VJMA300958300HC
9VJMA301028330HC
9VJMA401398550HG
9VJMA731558A10HG
9VJEF300958150HC
9VJEF301028165HC
9VJEF401398275HG
9VJEF731558550HG
9VJEF300958300HC
9VJEF301028330HC
9VJEF401398550HG

Reference
9VJEF731558A10HG
9VJAE731558550HG
9VJAE881898880HG
9VJAE731558A10HG
9VJAE881898A665G
9VJAE731558A155G
9VJAE881898B255G
9VJAD731558550HG
9VJAD881898880HG
9VJAD731558A10HG
9VJAD881898A665G
9VJAD731558A155G
9VJAD881898B255G
9VJAF731558550HG
9VJAF881898880HG
9VJAF731558A10HG
9VJAF881898A665G
9VJAF731558A155G
9VJAF881898B255G
9VJDAA0D398B205G
9VJDFA0D398B205G
9VJBEA0D398B205G
9VJBEA0D398D405G
9VJBEA0D398F005G
9VJBDA0D398B205G
9VJBDA0D398D405G
9VJBDA0D398F005G
9VJBFA0D398B205G
9VJBFA0D398D405G
9VJBFA0D398F005G
9V2CP6280000000
9V2CQ6280000A300
9V2CR62800006000
9V2CP64100000000
9V2CQ6410000B800
9V2CP64600000000
9V2CR64600008000
9V2CP65800000000
9V2CQ65800008000
9V2CR65800008000
9V2CP61001200020

Reference
9V2CP6100120A020
9V2EP4320
9V2EP450
9V2EP4500
9V2EP420
9V2EP71041240020
9V2D6030095
9V2D6030102
9V2D6040139
9V2D6073155
9V2D6088189
9V2D6100439
9V314173155N20
9V314173155AVF
9V314188189M20
9V314188189AVF
9V3142A0439N20
9V3142A0439AVF
9SWR2JRT0302680N
9SWR2JRS0302680N
9H0601252035001
9H06012520350N2
9H06012520350P2
Y8WTZ017010000UN
Y8WHQ0210100EAUQ
Y8WHQ02101000AUQ
Y8WJW021D100GFUQ
Y8WJW021D1000FUQ
Y8WJW021D100GFUS
TNR80E00I300B1K6
TSR80E00I300BBK6
TNR80E00I300S1K6
TSR80E00I300SBK6
Y8WSY060000000U9



Because of permanent improvement of our products, drawings, descriptions, features used on these data sheets are for guidance only and can be modified without prior advice



Because of permanent improvement of our products, drawings, descriptions, features used on these data sheets are for guidance only and can be modified without prior advice

# Antifreeze jacket heaters



## Safety instructions for all industrial jacket heaters described in this catalogue

- Read the user manual before any use
- Protect the power supply circuit by a differential circuit breaker of 20mA sensitivity, with rating adapted to the model that must be connected to it.
- This supply circuit must be carried out by a qualified electrician and according to the local standards in force.
- The earth circuit must be compliant and connected.
- The jacket heater must be disconnected when the container is empty.
- The jacket heater must be disconnected when filling the container.
- The jacket heater must be disconnected during installation or de-installation.
- The jacket heater must be stored in a dry place and protected from rodents and other animals during periods when it is not used.
- In some applications and especially when liquid overflow is possible, it may be necessary to connect the metal containers directly to a grounding conductor.
- The jacket heater must be used in a dry environment.
- Do not cut or punch the surface
- The container must be in communication with the atmospheric pressure to avoid the increase of its internal pressure and its explosion by dilation or boiling of the products which it contains. This setting at atmospheric pressure may for example be performed by unscrewing or removing a plug located in the upper part of the container. The use of a temperature sensor and/or stirrer using this upper orifice for their fastenings must not completely close this orifice.
- These appliances are not suitable for permanent outdoor use, and must be protected from rain, dust and condensation.
- Do not operate above the rated safety temperature (This temperature depends on the heated liquid, and must be checked before connecting the device).
- Use a jacket heater adapted to the size of the container
- The jacket heater must be in contact with the surface of the container to be heated, without superimposing heating parts. The superposition of two heating parts doubles the surface power and can cause melting of the jacket heater and initiate a fire in the most severe cases.
- Position the jacket heater so that it is in contact with the largest possible cylindrical surface of the container.
- These devices are not suitable for use in flammable or explosive areas.

# Antifreeze flexible jacket heaters for glass or plastic containers



Because of permanent improvement of our products, drawings, descriptions, features used on these data sheets are for guidance only and can be modified without prior advice

Containers material	Maximum temperature limited to :	Tightening	Thermostat	Insulation thickness	Type
Glass, Plastic	65°C	Nylon straps and metal buckle	Built-in, fixed setting at 5°C	10mm 20mm	<b>9VJ32</b>

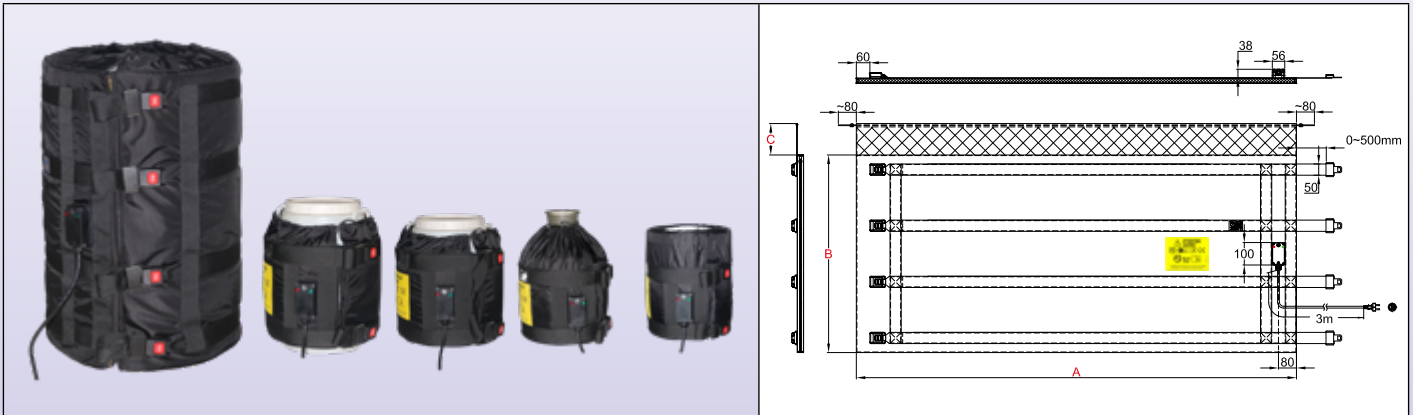

## Main Features

Flexible jacket heaters are used for antifreeze protection, reheating, temperature stabilization, to reduce viscosity or to melt soaps, animal or vegetable fats, varnishes, oils, food or chemical products.

This series of jacket heaters is the most efficient solution for heating glass or plastic containers. They are available for containers of 18L/20L (5 US gallons), 23L/25L (6 US gallons), 30L (8 US gallons), 60L (15 US gallons) and 110 liters (30 US gallons). The jacket heater covers almost the entire surface and is surmounted by a soft collar "a scarf" preventing it from sliding down. They can be made with two power levels ( $0.05\text{W}/\text{cm}^2$  and  $0.1\text{W}/\text{cm}^2$ ) and two thicknesses of insulation (10mm in standard and 20mm in option) to cover antifreeze applications even for very low temperatures. See these applications described in the technical introduction. They can also simply be used to maintain positive temperature of liquids.

In these models their surface temperature is limited to 65°C to prevent deformation or melting of plastic containers, or temperature stress breaking of glass containers.

When they are used with an insulated lid and an insulated pedestal, their energetic efficiency can rise 90%

## Technical characteristics

The heating element of the flexible jacket heater consists of a network of silicone insulated heating wires shielded by a metal braid, taken under a cover sewn in PU and Teflon coated polyester fabric. A 10mm thick, temperature-resistant NBR-PVC foam insulation is inserted between the heating network and the outer wall. This insulating foam has an insulation coefficient ( $\text{Lambda } \lambda$ ) of  $0.039\text{W}/\text{m.K}$ , and this makes it possible to divide the energy losses by 3 compared to jacket heaters insulated with mineral wool or carbon fiber felt of the same thickness. Adjustable metal buckles allow quick assembly and disassembly and efficient clamping on the container. Their mechanical strength is exceptional.

### Fabric covering:

- Internal heating face: Teflon coated polyester fabric,
- External side: waterproof PU coated polyester fabric.

### Thermal insulation:

NBR-PVC foam, with closed cells and high temperature resistance, thickness 10mm. This thickness is chosen for its great flexibility, important on small containers.

### Heating element:

Silicon insulated heating wire with metal braid providing mechanical protection against puncturing and good grounding.

### Temperature control:

By fixed setting bimetallic thermostat, opens at 9°C, closes at 5°C, mounted on the connection box, **and measuring the ambient temperature**. Two pilot lamps indicate the presence of voltage and the heating function. A temperature limiter is incorporated in the heating net to limit the surface temperature to 65°C.

### Connection cable:

Insulated rubber power supply cable, for industrial environments,  $3 \times 1\text{mm}^2$  length 3m, Euro plug. UL plug on request.

### Mounting on containers:

These jacket heaters feature nylon straps with quick-release adjustable buckles for adjustment to the diameter of the

# Antifreeze flexible jacket heaters for glass or plastic containers



container, and a soft fabric collar without thermal insulation named scarf. This flexible scarf can be used to hold in place an insulating lid in the case of cylindrical containers.

## Options:

- Insulating foam thickness 20mm for applications in very low temperatures.
- 0.135W/cm<sup>2</sup> surface load for fast heating. See technical introduction.
- Power supply 110/115V
- Power cord with industrial plug 2-pole + earth 16A CEE (IEC60309)
- Lids and insulating pedestals: see the accessories pages.

## Main references (see the technical introduction for the liquids heating time)

References*	Insulation (mm)**	Volume, US gallons	Volume, Liters	Dia. mm ± 12; Inch ± ½"	Height A (mm/inch)	Flat length B (mm/inch)	Collerette C (mm/inch)	w/cm <sup>2</sup> (W/in <sup>2</sup> )	Watt	Voltage V
9VJ32300958150HC	10	5	18/20	280 (11)	300 (11.8)	950 (37.4)	150 (5.9)	0,05 (0.32)	150	220/240
9VJ32301028165HC	10	6	25/30	280 (11)	300 (11.8)	1020 (40.2)	150 (5.9)	0,05 (0.32)	165	220/240
9VJ32401398275HG	10	15	50/60	410 (16.1)	400 (15.7)	1390 (54.7)	100 (3.9)	0,05 (0.32)	275	220/240
9VJ32731558550HG	10	30	110	460 (18.1)	730 (28.8)	1550 (61)	100 (3.9)	0,05 (0.32)	550	220/240
9VJ32300958300HC	10	5	20/25	280 (11)	300 (11.8)	900 (35.4)	150 (5.9)	0,1 (0.64)	300	220/240
9VJ32301028330HC	10	6	25/30	280 (11)	300 (11.8)	1020 (40.2)	150 (5.9)	0,1 (0.64)	330	220/240
9VJ32401398550HG	10	15	50/60	410 (16.1)	400 (15.7)	1390 (54.7)	100 (3.9)	0,1 (0.64)	550	220/240
9VJ32731558A10HG	10	30	110	460 (18.1)	730 (28.8)	1550 (61)	100 (3.9)	0,1 (0.64)	1100	220/240

\* For these products supplied with UL plug and not Euro plug, replace the 15th character by X.

\*\* Models with 20mm insulation, replace 9VJ3 by 9VJ2

Because of permanent improvement of our products, drawings, descriptions, features used on these data sheets are for guidance only and can be modified without prior advice





# Antifreeze flexible jacket heaters for metal drums and 1000 liter IBC

Because of permanent improvement of our products, drawings, descriptions, features used on these data sheets are for guidance only and can be modified without prior advice

Containers material	Maximum temperature limited to :	Tightening	Thermostat	Insulation thickness	Type
Metal or plastic with grid	65°C	Nylon straps and metal buckle	Built-in, fixed setting at 5°C	20mm	<b>9VJ22</b>

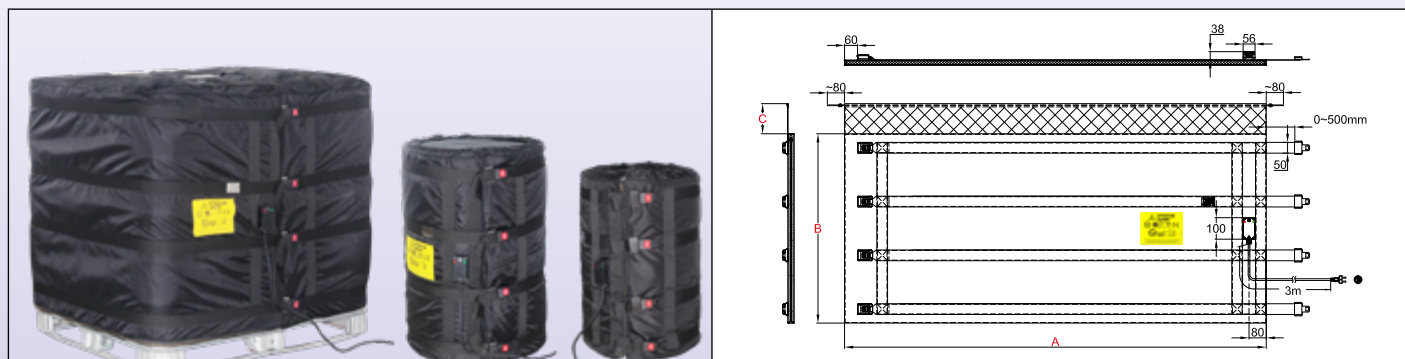

## Main Features

Flexible jacket heaters are used for antifreeze protection, reheating, temperature stabilization, to reduce viscosity or to melt soaps, animal or vegetable fats, varnishes, oils, food or chemical products.

This series of jacket heaters is the most efficient solution for heating glass or plastic containers. They are available for containers of 110L (30 US gallons), 210L (55US gallons) and 1000 liters IBC. The jacket heater covers the entire surface and is surmounted by a soft collar "a scarf" preventing it from sliding down. They can be made with two power levels (0.05W/cm<sup>2</sup> and 0.1W/cm<sup>2</sup>) and one 20mm thickness of insulation to cover antifreeze applications even for very low temperatures. See these applications described in the technical introduction. They can also simply be used to maintain positive temperature of liquids.

In these models their surface temperature is limited to 65°C. When they are used with an insulated lid and an insulated pedestal, their energetic efficiency can rise 90%

## Technical characteristics

The heating element of the flexible jacket heater consists of a network of silicone insulated heating wires shielded by a metal braid, taken under a cover sewn in PU and Teflon coated polyester fabric. A 20mm thick, temperature-resistant NBR-PVC foam insulation is inserted between the heating network and the outer wall. This insulating foam has an insulation coefficient (Lambda λ) of 0.039W/m.K, and this makes it possible to divide the energy losses by 3 compared to jacket heaters insulated with mineral wool or carbon fiber felt of the same thickness. Four adjustable metal buckles allow quick assembly and disassembly and efficient clamping on the container. Their mechanical strength is exceptional.

### Fabric covering:

- Internal heating face: Teflon coated polyester fabric,
- External side: waterproof PU coated polyester fabric.

### Thermal insulation:

NBR-PVC foam, with closed cells and high temperature resistance, thickness 20mm.

### Heating element:

Silicon insulated heating wire with metal braid providing mechanical protection against puncturing and good grounding.

### Temperature control:

By fixed setting bimetallic thermostat, opens at 9°C, closes at 5°C, mounted on the connection box, and **measuring the ambient temperature**. Two pilot lamps indicate the presence of voltage and the heating function. A temperature limiter is incorporated in the heating net to limit the surface temperature to 65°C.

### Connection cable:

Insulated rubber power supply cable, for industrial environments, 3 x 1mm<sup>2</sup> length 3m, Euro plug. (3x1.5mm<sup>2</sup> for the IBC model). UL plug on request.

### Mounting on containers:

These jacket heaters feature nylon straps with quick-release adjustable buckles for adjustment to the diameter of the container, and a soft fabric collar without thermal insulation named scarf. This flexible scarf can be used to hold in place an insulating lid.

### Options:

- 0.135W/cm<sup>2</sup> surface load for fast heating. (Not available for IBC in this temperature control version). See technical introduction.

# Antifreeze flexible jacket heaters for metal drums and 1000 liter IBC



- Power supply 110/115V
- Power cord with industrial plug 2-pole + earth 16A CEE (IEC60309)
- Lids and insulating pedestals: see the accessories pages.

## Main references (see the technical introduction for the liquids heating time)

References*	Volume, US gallons	Volume, Liters	Dia. (mm ± 12; Inch ± 1/2")	Height A (mm/inch)	Flat length B (mm/inch)	Scarf C (mm/inch)	w/cm <sup>2</sup> (W/in <sup>2</sup> )**	Watt	Voltage V
9VJ22731558550HG	30	110	460 (18.1)	730 (28.8)	1550 (61)	100 (3.9)	0,05 (0.32)	550	220/240
9VJ22881898880HG	55	210	585 (23)	880 (34.6)	1890 (74.4)	100 (3.9)	0,05 (0.32)	880	220/240
9VJ22A04398B205G	264	1000	1000 x 1200 (39.4 x 47.3)	1000 (39.4)	4390 (172.8)	100 (3.9)	0,05 (0.32)	2200	220/240
9VJ22731558A10HG	30	110	460 (18.1)	730 (28.8)	1550 (61)	100 (3.9)	0,1 (0.64)	1100	220/240
9VJ22881898A66HG	55	210	585 (23)	880 (34.6)	1890 (74.4)	100 (3.9)	0,1 (0.64)	1660	220/240

\* For these products supplied with UL plug and not Euro plug, replace the 15th character by X

\*\* In this temperature control version 0.1W/cm<sup>2</sup> and 0.135W/cm<sup>2</sup> are not available for IBC size

Because of permanent improvement of our products, drawings, descriptions, features used on these data sheets are for guidance only and can be modified without prior advice



Because of permanent improvement of our products, drawings, descriptions, features used on these data sheets are for guidance only and can be modified without prior advice

# Jacket heaters with fixed setting surface mounted temperature control



## **Safety instructions for all industrial jacket heaters described in this catalogue**

- Read the user manual before any use
- Protect the power supply circuit by a differential circuit breaker of 20mA sensitivity, with rating adapted to the model that must be connected to it.
- This supply circuit must be carried out by a qualified electrician and according to the local standards in force.
- The earth circuit must be compliant and connected.
- The jacket heater must be disconnected when the container is empty.
- The jacket heater must be disconnected when filling the container.
- The jacket heater must be disconnected during installation or de-installation.
- The jacket heater must be stored in a dry place and protected from rodents and other animals during periods when it is not used.
- In some applications and especially when liquid overflow is possible, it may be necessary to connect the metal containers directly to a grounding conductor.
- The jacket heater must be used in a dry environment.
- Do not cut or punch the surface
- The container must be in communication with the atmospheric pressure to avoid the increase of its internal pressure and its explosion by dilation or boiling of the products which it contains. This setting at atmospheric pressure may for example be performed by unscrewing or removing a plug located in the upper part of the container. The use of a temperature sensor and/or stirrer using this upper orifice for their fastenings must not completely close this orifice.
- These appliances are not suitable for permanent outdoor use, and must be protected from rain, dust and condensation.
- Do not operate above the rated safety temperature (This temperature depends on the heated liquid, and must be checked before connecting the device).
- Use a jacket heater adapted to the size of the container
- The jacket heater must be in contact with the surface of the container to be heated, without superimposing heating parts. The superposition of two heating parts doubles the surface power and can cause melting of the jacket heater and initiate a fire in the most severe cases.
- Position the jacket heater so that it is in contact with the largest possible cylindrical surface of the container.
- These devices are not suitable for use in flammable or explosive areas.



# Fixed temperature setting flexible jacket heaters for glass or plastic containers

Because of permanent improvement of our products, drawings, descriptions, features used on these data sheets are for guidance only and can be modified without prior advice

Containers material	Maximum temperature limited to :	Tightening	Thermostat	Insulation thickness	Type
Glass, Plastic	65°C	Nylon straps and metal buckle	Surface mounted, fixed setting temperature 65°C	10mm	<b>9VJV6</b>

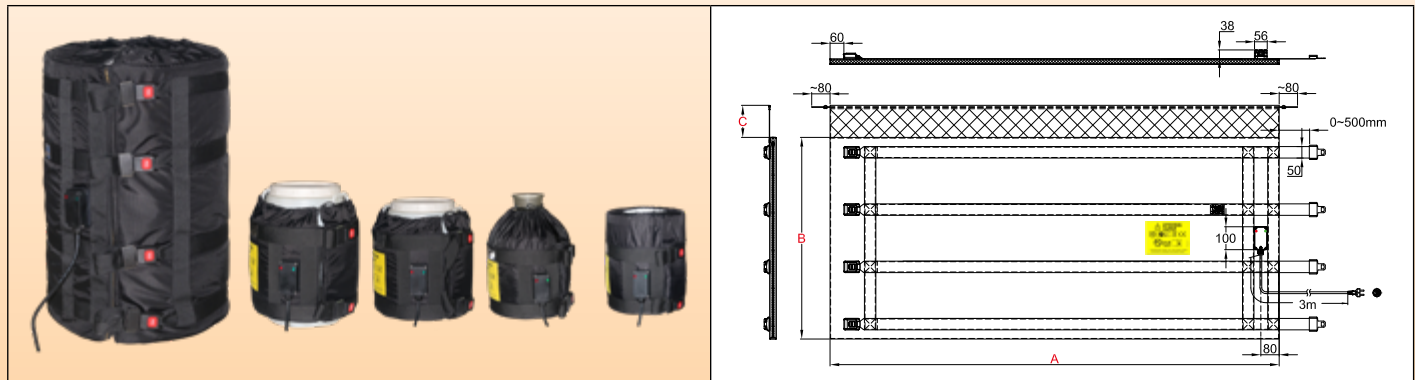

## Main Features

This **economical version** of flexible jacket heater is used to reduce viscosity or to melt soaps, animal or vegetable fats, varnishes, oils, food or chemical products.

It is the most efficient solution for heating glass or plastic containers. These models are available for containers of 18L/20L (5 US gallons), 23L/25L (6 US gallons), 30L (8 US gallons), 60L (15 US gallons) and 110 liters (30 US gallons). The jacket heater covers almost the entire surface and is surmounted by a soft collar "a scarf" preventing it from sliding down. They can be made with two power levels (0.05W/cm<sup>2</sup> and 0.1W/cm<sup>2</sup>) and two thicknesses of insulation (10mm in standard and 20mm in option). In these models the surface temperature is limited to 65°C to prevent deformation or melting of plastic containers, or temperature stress breaking of glass containers.

When they are used with an insulated lid and an insulated pedestal, their energetic efficiency can rise 90%.

## Technical characteristics

The heating element of the flexible jacket heater consists of a network of silicone insulated heating wires shielded by a metal braid, taken under a cover sewn in PU and Teflon coated polyester fabric. A temperature-resistant NBR-PVC foam insulation is inserted between the heating network and the outer wall. This insulating foam has an insulation coefficient (Lambda λ) of 0.039W/m.K, and this makes it possible to divide the energy losses by 3 compared to jacket heaters insulated with mineral wool or carbon fiber felt of the same thickness. Adjustable **metal** buckles allow quick assembly and disassembly and efficient clamping on the container. Their mechanical strength is exceptional.

### Fabric covering:

- Internal heating face: Teflon coated polyester fabric,
- External side: waterproof PU coated polyester fabric.

### Thermal insulation:

NBR-PVC foam, with closed cells and high temperature resistance, thickness 10mm. This thickness is chosen for its great flexibility, important on small containers.

### Heating element:

Silicon rubber insulated heating wire with metal braid providing mechanical protection against puncturing and good grounding.

### Temperature control:

A temperature limiter is incorporated in the heating net to limit the surface temperature to 65°C. Two pilot lamps indicate the presence of voltage and the heating function.

**Warning:** these models start to heat up as soon as you connect them to the power supply.

### Connection cable:

Insulated rubber power supply cable, for industrial environments, 3 x 1mm<sup>2</sup> length 3m, Euro plug. UL plug on request.

### Mounting on containers:

These jacket heaters feature nylon straps with quick-release adjustable buckles for adjustment to the diameter of the container, and a soft fabric collar without thermal insulation named scarf. This flexible scarf can be used to hold in place an insulating lid in the case of cylindrical containers.

### Options:

- 0.135W/cm<sup>2</sup> surface load for fast heating. See technical introduction.

# Fixed temperature setting flexible jacket heaters for glass or plastic containers



- Power supply 110/115V
- Power cord with industrial plug 2-pole + earth 16A CEE (IEC60309)
- Lids and insulated pedestals: see the accessories pages.

**Compliance with standards:** CE compliant. TUV certificate: EEC Low Voltage Directive (LVD) and EMC directive 2004/108/EC, and CE marked accordingly.

## Main references (see the technical introduction for the liquids heating time)

References*	Insulation (mm)**	Volume, US gallons	Volume, Liters	Dia. (mm ± 12; Inch ± ½")	Height A (mm/inch)	Flat length B (mm/inch)	Scarf C (mm/inch)	w/cm <sup>2</sup> (W/in <sup>2</sup> )	Watt	Voltage V
9VJV6300958150HC	10	5	18/20	280 (11)	300 (11.8)	950 (37.4)	150 (5.9)	0,05 (0.32)	150	220/240
9VJV6301028165HC	10	6	25/30	280 (11)	300 (11.8)	1020 (40.2)	150 (5.9)	0,05 (0.32)	165	220/240
9VJV6401398275HG	10	15	50/60	410 (16.1)	400 (15.7)	1390 (54.7)	100 (3.9)	0,05 (0.32)	275	220/240
9VJV6731558550HG	10	30	110	460 (18.1)	730 (28.8)	1550 (61)	100 (3.9)	0,05 (0.32)	550	220/240
9VJV6300958300HC	10	5	20/25	280 (11)	300 (11.8)	900 (35.4)	150 (5.9)	0,1 (0.64)	300	220/240
9VJV6301028330HC	10	6	25/30	280 (11)	300 (11.8)	1020 (40.2)	150 (5.9)	0,1 (0.64)	330	220/240
9VJV6401398550HG	10	15	50/60	410 (16.1)	400 (15.7)	1390 (54.7)	100 (3.9)	0,1 (0.64)	550	220/240
9VJV6731558A10HG	10	30	110	460 (18.1)	730 (28.8)	1550 (61)	100 (3.9)	0,1 (0.64)	1100	220/240

\* For these products supplied with UL plug and not Euro plug, replace the 15th character by X.

\*\* Models with 20mm insulation, replace 9VJV6 by 9VJF6

Because of permanent improvement of our products, drawings, descriptions, features used on these data sheets are for guidance only and can be modified without prior advice

# Fixed temperature setting flexible jacket heaters for metal drums and 1000 liters IBC



Because of permanent improvement of our products, drawings, descriptions, features used on these data sheets are for guidance only and can be modified without prior advice

Containers material	Maximum temperature limited to :	Tightening	Thermostat	Insulation thickness	Type
Metal or plastic with grid	65°C	Nylon straps and metal buckle	Surface mounted, fixed setting temperature 65°C	20mm	<b>9VJF6</b>

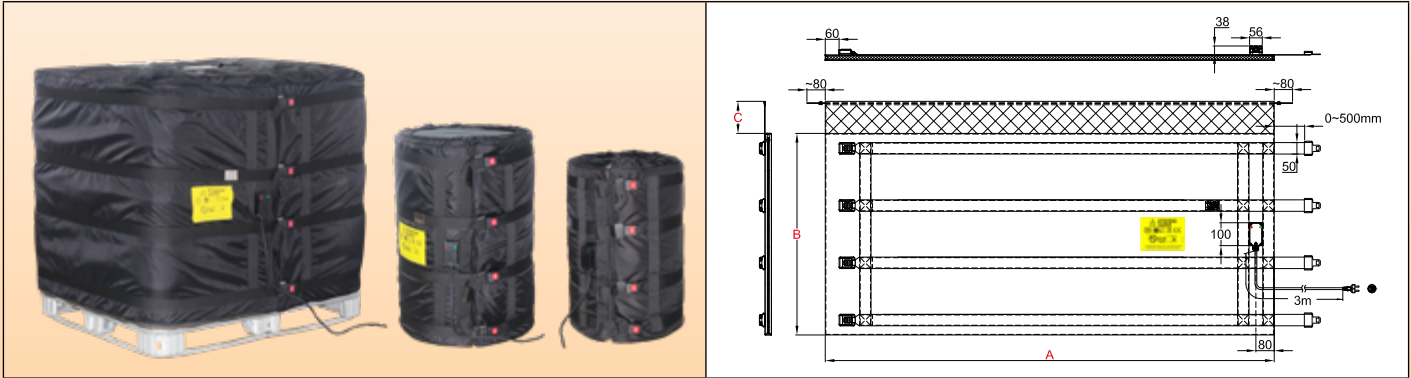

## Main Features

This **economical version** of flexible jacket heater is used to reduce viscosity or to melt soaps, animal or vegetable fats, varnishes, oils, food or chemical products.

These models are available for containers of 110L (30 US gallons), 210L (55US gallons) and 1000 liters IBC. The jacket heater covers the entire surface and is surmounted by a soft collar "a scarf" preventing it from sliding down. They can be made with two power levels ( $0.05\text{W}/\text{cm}^2$  and  $0.1\text{W}/\text{cm}^2$ ) and insulation thicknesses of 20mm. In these models the surface temperature is limited to 65°C.

When they are used with an insulated lid and an insulated pedestal, their energetic efficiency can rise 90%.

## Technical characteristics

The heating element of the flexible jacket heater consists of a network of silicone insulated heating wires shielded by a metal braid, taken under a cover sewn in PU and Teflon coated polyester fabric. A 20mm thick, temperature-resistant NBR-PVC foam insulation is inserted between the heating network and the outer wall. This insulating foam has an insulation coefficient ( $\text{Lambda } \lambda$ ) of  $0.039\text{W}/\text{m.K}$ , and this makes it possible to divide the energy losses by 3 compared to jacket heaters insulated with mineral wool or carbon fiber felt of the same thickness. Four adjustable **metal** buckles allow quick assembly and disassembly and efficient clamping on the container. Their mechanical strength is exceptional.

### Fabric covering:

- Internal heating face: Teflon coated polyester fabric,
- External side: waterproof PU coated polyester fabric.

### Thermal insulation:

NBR-PVC foam, with closed cells and high temperature resistance, thickness 20mm.

### Heating element:

Silicon insulated heating wire with metal braid providing mechanical protection against puncturing and good grounding.

### Temperature control:

A temperature limiter is incorporated in the heating net to limit the surface temperature to 65°C. Two pilot lamps indicate the presence of voltage and the heating function.

**Warning: these models start to heat up as soon as you connect them to the power supply.**

### Connection cable:

Insulated rubber power supply cable, for industrial environments,  $3 \times 1\text{mm}^2$  length 3m, Euro plug. ( $3 \times 1.5\text{mm}^2$  for the IBC model). UL plug on request.

### Mounting on containers:

These jacket heaters feature nylon straps with quick-release adjustable buckles for adjustment to the diameter of the container, and a soft fabric collar without thermal insulation named scarf. This flexible scarf can be used to hold in place an insulating lid.

### Options:

- $0.135\text{W}/\text{cm}^2$  surface load for fast heating. (Not available for IBC in this temperature control version). See technical introduction.
- Power supply 110/115V
- Power cord with industrial plug 2-pole + earth 16A CEE (IEC60309)

# Fixed temperature setting flexible jacket heaters for metal drums and 1000 liters IBC



- Lids and insulated pedestals: see the accessories pages.

**Compliance with standards:** CE compliant. TUV certificate: EEC Low Voltage Directive (LVD) and EMC directive 2004/108/EC, and CE marked accordingly.

## Main references (see the technical introduction for the liquids heating time)

References*	Volume, US gallons	Volume, Liters	Dia. (mm ± 12; Inch ± ½")	Height A (mm/inch)	Flat length B (mm/inch)	Scarf C (mm/inch)	w/cm <sup>2</sup> (W/in <sup>2</sup> )**	Watt	Voltage V
9VJF6731558550HG	30	110	460 (18.1)	730 (28.8)	1550 (61)	100 (3.9)	0,05 (0.32)	550	220/240
9VJF6881898880HG	55	210	585 (23)	880 (34.6)	1890 (74.4)	100 (3.9)	0,05 (0.32)	880	220/240
9VJF6A0D398B205G	264	1000	1000 x 1200 (39.4 x 47.3)	1000 (39.4)	4390 (172.8)	100 (3.9)	0,05 (0.32)	2200	220/240
9VJF6731558A10HG	30	110	460 (18.1)	880 (34.6)	1550 (61)	100 (3.9)	0,1 (0.64)	1100	220/240
9VJF6881898550HG	55	210	585 (23)	1000 (39.4)	1890 (74.4)	100 (3.9)	0,1 (0.64)	1660	220/240

\* For these products supplied with UL plug and not Euro plug, replace the 15th character by X.

\*\* In this temperature control version 0.1W/cm<sup>2</sup> and 0.135W/cm<sup>2</sup> are not available for IBC size.

Because of permanent improvement of our products, drawings, descriptions, features used on these data sheets are for guidance only and can be modified without prior advice





Because of permanent improvement of our products, drawings, descriptions, features used on these data sheets are for guidance only and can be modified without prior advice

# **Jacket heaters with adjustable electronic thermostat for reheating small plastic or glass containers**



## **Safety instructions for all industrial jacket heaters described in this catalogue**

- Read the user manual before any use
- Protect the power supply circuit by a differential circuit breaker of 20mA sensitivity, with rating adapted to the model that must be connected to it.
- This supply circuit must be carried out by a qualified electrician and according to the local standards in force.
- The earth circuit must be compliant and connected.
- The jacket heater must be disconnected when the container is empty.
- The jacket heater must be disconnected when filling the container.
- The jacket heater must be disconnected during installation or de-installation.
- The jacket heater must be stored in a dry place and protected from rodents and other animals during periods when it is not used.
- In some applications and especially when liquid overflow is possible, it may be necessary to connect the metal containers directly to a grounding conductor.
- The jacket heater must be used in a dry environment.
- Do not cut or punch the surface
- The container must be in communication with the atmospheric pressure to avoid the increase of its internal pressure and its explosion by dilation or boiling of the products which it contains. This setting at atmospheric pressure may for example be performed by unscrewing or removing a plug located in the upper part of the container. The use of a temperature sensor and/or stirrer using this upper orifice for their fastenings must not completely close this orifice.
- These appliances are not suitable for permanent outdoor use, and must be protected from rain, dust and condensation.
- Do not operate above the rated safety temperature (This temperature depends on the heated liquid, and must be checked before connecting the device).
- Use a jacket heater adapted to the size of the container
- The jacket heater must be in contact with the surface of the container to be heated, without superimposing heating parts. The superposition of two heating parts doubles the surface power and can cause melting of the jacket heater and initiate a fire in the most severe cases.
- Position the jacket heater so that it is in contact with the largest possible cylindrical surface of the container.
- These devices are not suitable for use in flammable or explosive areas.

# Flexible jacket heaters with adjustable electronic thermostat, **surface mounted**, for glass or plastic containers



Because of permanent improvement of our products, drawings, descriptions, features used on these data sheets are for guidance only and can be modified without prior advice

Containers material	Maximum temperature limited to :	Tightening	Thermostat	Insulation thickness	Type
Glass, Plastic	65°C	Nylon straps and metal buckle	Electronic, set point adjustable by knob from 4 to 40°C	10mm (20mm)	<b>9VJMA</b>

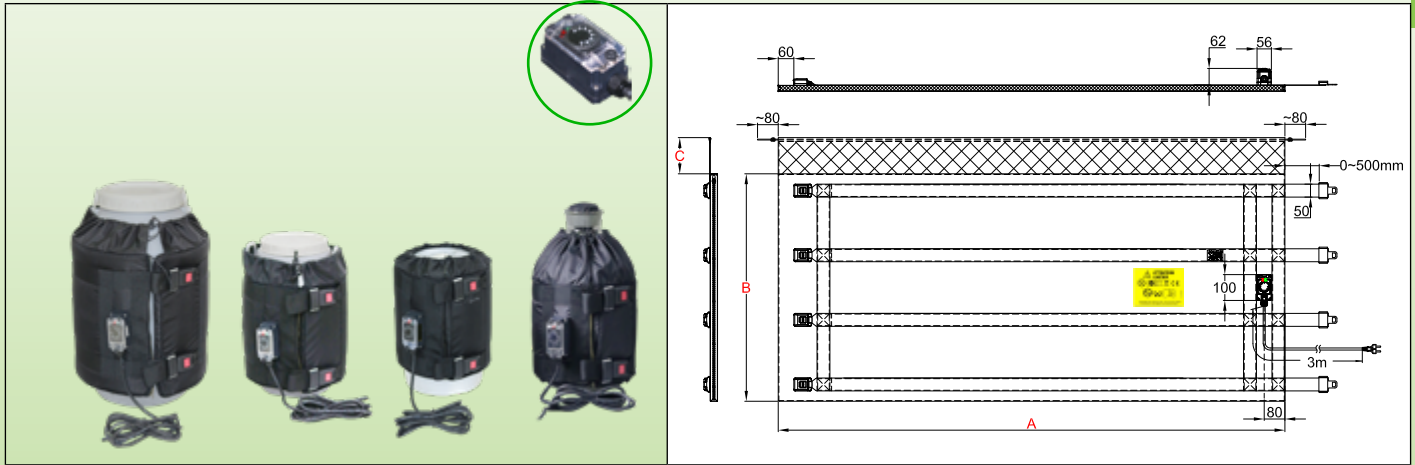

## Main Features

Thanks to its **adjustable electronic thermostat**, these flexible jacket heaters are used for antifreeze protection, reheating, temperature stabilization, to reduce viscosity or to melt soaps, animal or vegetable fats, varnishes, oils, food or chemical products.

This series of jacket heaters is the most **universal** solution for **heating at a set temperature** glass or plastic containers. They are available for containers of 18L/20L (5 US gallons), 23L/25L (6 US gallons), 30L (8 US gallons), 60L (15 US gallons) and 110 liters (30 US gallons). The jacket heater covers almost the entire surface and is surmounted by a soft collar "a scarf" preventing it from sliding down. They can be made with two power levels (0.05W/cm<sup>2</sup> and 0.1W/cm<sup>2</sup>) and two thicknesses of insulation (10mm in standard and 20mm in option) to cover antifreeze applications even for very low temperatures. See these applications described in the technical introduction. They can also simply be used to maintain positive temperature of liquids.

In these models their surface temperature is limited to 65°C to prevent deformation or melting of plastic containers, or temperature stress breaking of glass containers.

When they are used with an insulated lid and an insulated pedestal, their energetic efficiency can rise 90%.

## Technical characteristics

The heating element of the flexible jacket heater consists of a network of silicone insulated heating wires shielded by a metal braid, taken under a cover sewn in PU and Teflon coated polyester fabric. A 10mm thick, temperature-resistant NBR-PVC foam insulation is inserted between the heating network and the outer wall. This insulating foam has an insulation coefficient (Lambda  $\lambda$ ) of 0.039W/m.K, and this makes it possible to divide the energy losses by 3 compared to jacket heaters insulated with mineral wool or carbon fiber felt of the same thickness. Adjustable **metal** buckles allow quick assembly and disassembly and efficient clamping on the container. Their mechanical strength is exceptional.

### Fabric covering:

- Internal heating face: Teflon coated polyester fabric,
- External side: waterproof PU coated polyester fabric.

### Thermal insulation:

NBR-PVC foam, with closed cells and high temperature resistance, thickness 10mm. This thickness is chosen for its great flexibility, important on small containers.

### Heating element:

Silicon insulated heating wire with metal braid providing mechanical protection against puncturing and good grounding.

### Temperature control:

By an electronic thermostat adjustable from 4 to 40°C, located in a **waterproof** box mounted on the **external surface of the jacket heater**. It controls the temperature by means of a thermistor probe placed on the inner surface of the fabric in contact with the container. This probe has an anticipation loop avoiding overheating. Two pilot lamps indicate the presence of voltage and the heating function. A temperature limiter is incorporated in the heating net to limit the surface temperature to 65°C.

# Flexible jacket heaters with adjustable electronic thermostat, **surface mounted**, for glass or plastic containers



## Connection cable:

Insulated rubber power supply cable, for industrial environments, 3 x 1mm<sup>2</sup> length 3m, Euro plug. UL plug on request.

## Mounting on containers:

These jacket heaters feature nylon straps with quick-release adjustable buckles for adjustment to the diameter of the container, and a soft fabric collar without thermal insulation named scarf. This flexible scarf can be used to hold in place an insulating lid in the case of cylindrical containers.

## Options:

- Electronic thermostat temperature range from -40 to +40°C
- Insulating foam thickness 20mm for applications in very low temperatures.
- 0.135W/cm<sup>2</sup> surface load for fast heating. See technical introduction.
- Power supply 110/115V
- Power cord with industrial plug 2-pole + earth 16A CEE (IEC60309)
- Lids and insulating pedestals: see the accessories pages.

## Main references (see the technical introduction for the liquids heating time)

References*	Insulation (mm)**	Volume, US gallons	Volume, Liters	Dia. (mm ± 12; Inch ± ½")	Height A (mm/inch)	Flat length B (mm/inch)	Scarf C (mm/inch)	w/cm <sup>2</sup> (W/in <sup>2</sup> )	Watt	Voltage V
9VJMA300958150HC	10	5	18/20	280 (11)	300 (11.8)	950 (37.4)	150 (5.9)	0,05 (0.32)	150	220/240
9VJMA301028165HC	10	6	25/30	280 (11)	300 (11.8)	1020 (40.2)	150 (5.9)	0,05 (0.32)	165	220/240
9VJMA401398275HG	10	15	50/60	410 (16.1)	400 (15.7)	1390 (54.7)	100 (3.9)	0,05 (0.32)	275	220/240
9VJMA731558550HG	10	30	110	460 (18.1)	730 (28.8)	1550 (61)	100 (3.9)	0,05 (0.32)	550	220/240
9VJMA300958300HC	10	5	20/25	280 (11)	300 (11.8)	900 (35.4)	150 (5.9)	0,1 (0.64)	300	220/240
9VJMA301028330HC	10	6	25/30	280 (11)	300 (11.8)	1020 (40.2)	150 (5.9)	0,1 (0.64)	330	220/240
9VJMA401398550HG	10	15	50/60	410 (16.1)	400 (15.7)	1390 (54.7)	100 (3.9)	0,1 (0.64)	550	220/240
9VJMA731558A10HG	10	30	110	460 (18.1)	730 (28.8)	1550 (61)	100 (3.9)	0,1 (0.64)	1100	220/240

\* For these products supplied with UL plug and not Euro plug, replace the 15th character by X.

\*\* Models with 20mm insulation, replace 9VJMA by 9VJEA

Because of permanent improvement of our products, drawings, descriptions, features used on these data sheets are for guidance only and can be modified without prior advice

# Flexible jacket heaters with **remote** digital display electronic controller for glass or plastic containers



Containers material	Maximum temperature limited to :	Tightening	Thermostat	Insulation thickness	Type
Metal or plastic with grid	135°C	Nylon straps and metal buckle	Digital display, remote control	20mm	<b>9VJEF</b>

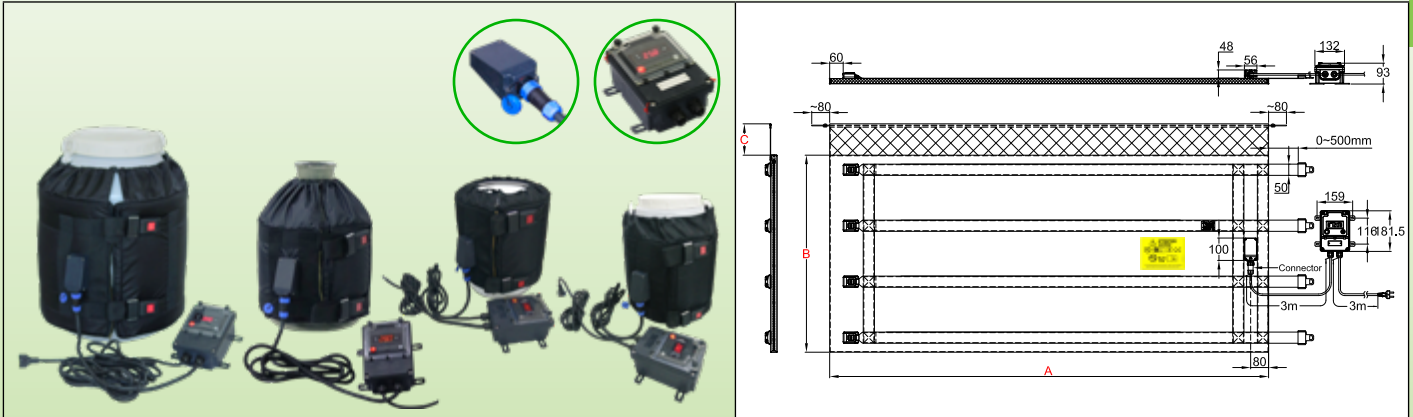

## Main Features

Thanks to its adjustable digital display temperature controller, these flexible jacket heaters are used for antifreeze protection, reheating, temperature stabilization, to reduce viscosity or to melt soaps, animal or vegetable fats, varnishes, oils, food or chemical products.

This series of jacket heaters is the most professional solution for heating at a set temperature glass or plastic containers. The wall mounting of the control box, as well as the quick connector ensuring the connection of this box on the jacket heater facilitate industrial use in a fixed working place in a production line. They are available for containers of 18L/20L (5 US gallons), 23L/25L (6 US gallons), 30L (8 US gallons), 60L (15 US gallons) and 110 liters (30 US gallons). The jacket heater covers almost the entire surface and is surmounted by a soft collar "a scarf" preventing it from sliding down. They can be made with two power levels (0.05W/cm<sup>2</sup> and 0.1W/cm<sup>2</sup>) 20mm thicknesses of insulation to cover antifreeze applications even for very low temperatures. See these applications described in the technical introduction. They can also simply be used to maintain positive temperature of liquids.

In these models their surface temperature is limited to 65°C to prevent deformation or melting of plastic containers, or temperature stress breaking of glass containers.

When they are used with an insulated lid and an insulated pedestal, their energetic efficiency can rise 90%.

## Technical characteristics

The heating element of the flexible jacket heater consists of a network of silicone insulated heating wires shielded by a metal braid, taken under a cover sewn in PU and Teflon coated polyester fabric. A 20mm thick, temperature-resistant NBR-PVC foam insulation is inserted between the heating network and the outer wall. This insulating foam has an insulation coefficient (Lambda  $\lambda$ ) of 0.039W/m.K, and this makes it possible to divide the energy losses by 3 compared to jacket heaters insulated with mineral wool or carbon fiber felt of the same thickness. Adjustable metal buckles allow quick assembly and disassembly and efficient clamping on the container. Their mechanical strength is exceptional.

### Fabric covering:

- Internal heating face: Teflon coated polyester fabric,
- External side: waterproof PU coated polyester fabric.

### Thermal insulation:

NBR-PVC foam, with closed cells and high temperature resistance, thickness 20mm.

### Heating element:

Silicon insulated heating wire with metal braid providing mechanical protection against puncturing and good grounding.

### Temperature control:

By electronic controller with digital display, On-Off action, relay output, located in an independent waterproof housing, designed for wall mounting. It is connected to the heating blanket by a cable equipped with a 5-pin waterproof quick connector, facilitating the connection and disconnection with the jacket heater. It controls the temperature by means of a thermistor probe placed on the inner surface of the fabric in contact with the container. This probe has an anticipation loop avoiding overheating. A temperature limiter is incorporated in the heating net to limit the surface temperature to 65°C.

### Connection cable:

Insulated rubber power supply cable, for industrial environments, 3 x 1mm<sup>2</sup> length 3m, Euro plug. UL plug on request.

# Flexible jacket heaters with **remote** digital display electronic controller for glass or plastic containers



## Mounting on containers:

These jacket heaters feature nylon straps with quick-release adjustable buckles for adjustment to the diameter of the container, and a soft fabric collar without thermal insulation named scarf. This flexible scarf can be used to hold in place an insulating lid.

## Options:

- 0.135W/cm<sup>2</sup> surface load for fast heating. See technical introduction.
- Power supply 110/115V
- Power cord with industrial plug 2-pole + earth 16A CEE (IEC60309)
- Lids and insulating pedestals: see the accessories pages.

**Compliance with standards:** CE compliant. TUV certificate for EEC Low Voltage Directive (LVD) and EMC directive 2004/108/EC, and CE marked accordingly

## Main references (see the technical introduction for the liquids heating time)

References*	Insulation (mm)**	Volume, US gallons	Volume, Liters	Dia. (mm ± 12; Inch ± 1/8")	Height A (mm/inch)	Flat length B (mm/inch)	Scarf C (mm/inch)	w/cm <sup>2</sup> (W/in <sup>2</sup> )	Watt	Voltage V
9VJEF300958150HC	20	5	18/20	280 (11)	300 (11.8)	950 (37.4)	150 (5.9)	0,05 (0.32)	150	220/240
9VJEF301028165HC	20	6	25/30	280 (11)	300 (11.8)	1020 (40.2)	150 (5.9)	0,05 (0.32)	165	220/240
9VJEF401398275HG	20	15	50/60	410 (16.1)	400 (15.7)	1390 (54.7)	100 (3.9)	0,05 (0.32)	275	220/240
9VJEF731558550HG	20	30	110	460 (18.1)	730 (28.8)	1550 (61)	100 (3.9)	0,05 (0.32)	550	220/240
9VJEF300958300HC	20	5	20/25	280 (11)	300 (11.8)	900 (35.4)	150 (5.9)	0,1 (0.64)	300	220/240
9VJEF301028330HC	20	6	25/30	280 (11)	300 (11.8)	1020 (40.2)	150 (5.9)	0,1 (0.64)	330	220/240
9VJEF401398550HG	20	15	50/60	410 (16.1)	400 (15.7)	1390 (54.7)	100 (3.9)	0,1 (0.64)	550	220/240
9VJEF731558A10HG	10	30	110	460 (18.1)	730 (28.8)	1550 (61)	100 (3.9)	0,1 (0.64)	1100	220/240

\* For these products supplied with UL plug and not Euro plug, replace the 15th character by X.

Because of permanent improvement of our products, drawings, descriptions, features used on these data sheets are for guidance only and can be modified without prior advice



Because of permanent improvement of our products, drawings, descriptions, features used on these data sheets are for guidance only and can be modified without prior advice

# **Jacket heaters with adjustable electronic thermostat for reheating metal containers**



## Safety instructions for all industrial jacket heaters described in this catalogue

- Read the user manual before any use
- Protect the power supply circuit by a differential circuit breaker of 20mA sensitivity, with rating adapted to the model that must be connected to it.
- This supply circuit must be carried out by a qualified electrician and according to the local standards in force.
- The earth circuit must be compliant and connected.
- The jacket heater must be disconnected when the container is empty.
- The jacket heater must be disconnected when filling the container.
- The jacket heater must be disconnected during installation or de-installation.
- The jacket heater must be stored in a dry place and protected from rodents and other animals during periods when it is not used.
- In some applications and especially when liquid overflow is possible, it may be necessary to connect the metal containers directly to a grounding conductor.
- The jacket heater must be used in a dry environment.
- Do not cut or punch the surface
- The container must be in communication with the atmospheric pressure to avoid the increase of its internal pressure and its explosion by dilation or boiling of the products which it contains. This setting at atmospheric pressure may for example be performed by unscrewing or removing a plug located in the upper part of the container. The use of a temperature sensor and/or stirrer using this upper orifice for their fastenings must not completely close this orifice.
- These appliances are not suitable for permanent outdoor use, and must be protected from rain, dust and condensation.
- Do not operate above the rated safety temperature (This temperature depends on the heated liquid, and must be checked before connecting the device).
- Use a jacket heater adapted to the size of the container
- The jacket heater must be in contact with the surface of the container to be heated, without superimposing heating parts. The superposition of two heating parts doubles the surface power and can cause melting of the jacket heater and initiate a fire in the most severe cases.
- Position the jacket heater so that it is in contact with the largest possible cylindrical surface of the container.
- These devices are not suitable for use in flammable or explosive areas.



# Flexible jacket heaters with 20-125°C adjustable electronic thermostat, surface mounted, for metal containers



Because of permanent improvement of our products, drawings, descriptions, features used on these data sheets are for guidance only and can be modified without prior advice

Containers material	Maximum temperature limited to :	Tightening	Thermostat	Insulation thickness	Type
Metal	135°C	Nylon straps and metal buckle	Electronic, set point adjustable by knob from 20 to 125°C	20mm	<b>9VJAE</b>

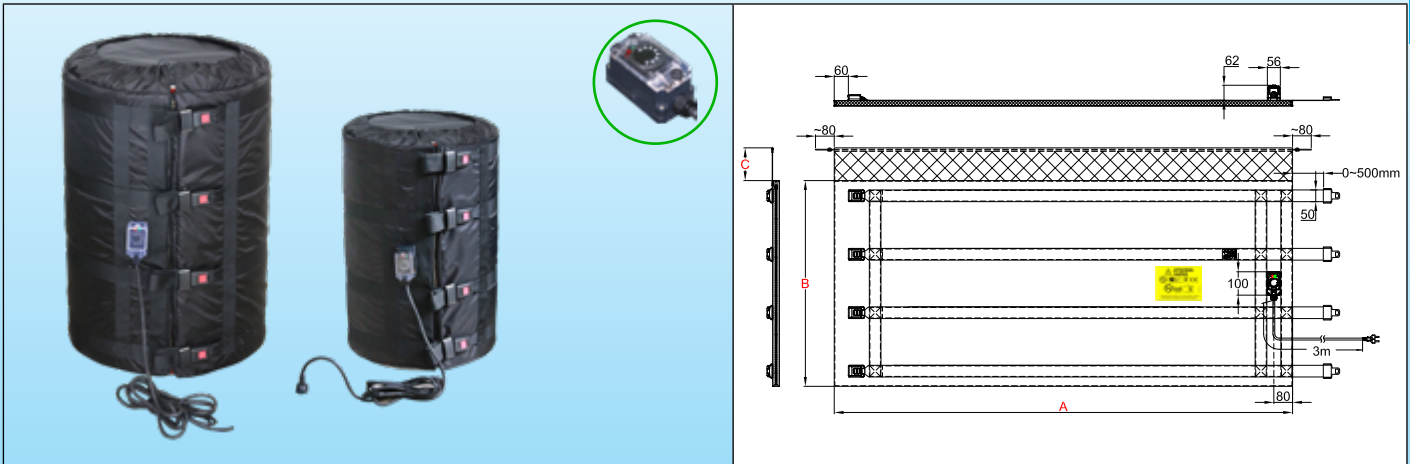

## Main Features

Thanks to its electronic thermostat, knob adjustable from 20 to 125°C, these flexible jacket heaters are used for antifreeze protection, reheating, temperature stabilization, to reduce viscosity or to melt soaps, animal or vegetable fats, varnishes, oils, food or chemical products.

This series of jacket heaters is the most **universal** solution, with economical electronic thermostat for **heating at a set temperature** glass or plastic containers. They are available for containers of 110L (30 US gallons) and 210L (55US gallons). The jacket heater covers the entire surface and is surmounted by a soft collar "a scarf" preventing it from sliding down. They are made **with three power levels**: (0.05W/cm<sup>2</sup> for temperature up to 50°C, 0.1W/cm<sup>2</sup> for temperature up to 80°C, and 0.135W/cm<sup>2</sup> for temperature up to 110°C). Their thickness of insulation is 20mm. In these models the surface temperature is limited to 135°C. When they are used with an insulated lid and an insulated pedestal, their energetic efficiency can rise 90%

## Technical characteristics

The heating element of the flexible jacket heater consists of a network of silicone insulated heating wires shielded by a metal braid, taken under a cover sewn in PU and Teflon coated polyester fabric. A 20mm thick, temperature-resistant NBR-PVC foam insulation is inserted between the heating network and the outer wall. This insulating foam has an insulation coefficient (Lambda λ) of 0.039W/m.K, and this makes it possible to divide the energy losses by 3 compared to jacket heaters insulated with mineral wool or carbon fiber felt of the same thickness. Adjustable **metal** buckles allow quick assembly and disassembly and efficient clamping on the container. Their mechanical strength is exceptional.

### Fabric covering:

- Internal heating face: Teflon coated polyester fabric,
- External side: waterproof PU coated polyester fabric.

### Thermal insulation:

NBR-PVC foam, with closed cells and high temperature resistance, thickness 20mm.

### Heating element:

Silicon insulated heating wire with metal braid providing mechanical protection against puncturing and good grounding.

### Temperature control:

By an electronic thermostat adjustable from 20 to 125°C, located in a **waterproof** box mounted on the **external surface of the jacket heater**. It controls the temperature by means of a thermistor probe placed on the inner surface of the fabric in contact with the container. This probe has an anticipation loop avoiding overheating. A temperature limiter is incorporated in the heating net to limit the surface temperature to 135°C.

### Connection cable:

Insulated rubber power supply cable, for industrial environments, 3 x 1mm<sup>2</sup> or 3x1.5mm<sup>2</sup> (depending of power), length 3m, Euro plug. UL plug on request.

### Mounting on containers:

These jacket heaters feature nylon straps with quick-release adjustable buckles for adjustment to the diameter of the

# Flexible jacket heaters with 20-125°C adjustable electronic thermostat, surface mounted, for metal containers



container, and a soft fabric collar without thermal insulation named scarf. This flexible scarf can be used to hold in place an insulating lid in the case of cylindrical containers.

## Options:

- Electronic thermostat temperature range -40+40°C, 4-40°C, 30-90°C, 30-110°C
- Power supply 110/115V
- Power cord with industrial plug 2-pole + earth 16A CEE (IEC60309)
- Lids and insulating pedestals: see the accessories pages.

**Compliance with standards:** CE compliant. TUV certificate for EEC Low Voltage Directive (LVD) and EMC directive 2004/108/EC, and CE marked accordingly.

## Main references (see the technical introduction for the liquids heating time)

References*	Volume, US gallons	Volume, Liters	Dia. (mm ± 12; Inch ± 1/2")	Height A (mm/inch)	Flat length B (mm/inch)	Scarf C (mm/inch)	w/cm <sup>2</sup> (W/in <sup>2</sup> )**	Max temp. °C	Watt	Voltage V
9VJAE731558550HG	30	110	460 (18.1)	730 (28.8)	1550 (61)	100 (3.9)	0,05 (0.32)	50	550	220/240
9VJAE881898880HG	55	210	585 (23)	880 (34.6)	1890 (74.4)	100 (3.9)	0,05 (0.32)	50	880	220/240
9VJAE731558A10HG	30	110	460 (18.1)	880 (34.6)	1550 (61)	100 (3.9)	0,1 (0.64)	80	1100	220/240
9VJAE881898A665G	55	210	460 (18.1)	1000 (39.4)	1890 (74.4)	100 (3.9)	0,1 (0.64)	80	1660	220/240
9VJAE731558A155G	30	110	460 (18.1)	880 (34.6)	1550 (61)	100 (3.9)	0,135 (0.86)	110	1500	220/240
9VJAE881898B255G	55	210	460 (18.1)	1000 (39.4)	1890 (74.4)	100 (3.9)	0,135 (0.86)	110	2250	220/240

\* For these products supplied with UL plug and not Euro plug, replace the 15th character by X.

Because of permanent improvement of our products, drawings, descriptions, features used on these data sheets are for guidance only and can be modified without prior advice

# Flexible jacket heaters with **digital display electronic controller**, adjustable up to **120°C**, **surface mounted**, for metal containers



Because of permanent improvement of our products, drawings, descriptions, features used on these data sheets are for guidance only and can be modified without prior advice

Containers material	Maximum temperature limited to :	Tightening	Thermostat	Insulation thickness	Type
Metal	135°C	Nylon straps and metal buckle	Electronic, set point adjustable up to 120°C	20mm	<b>9VJAD</b>

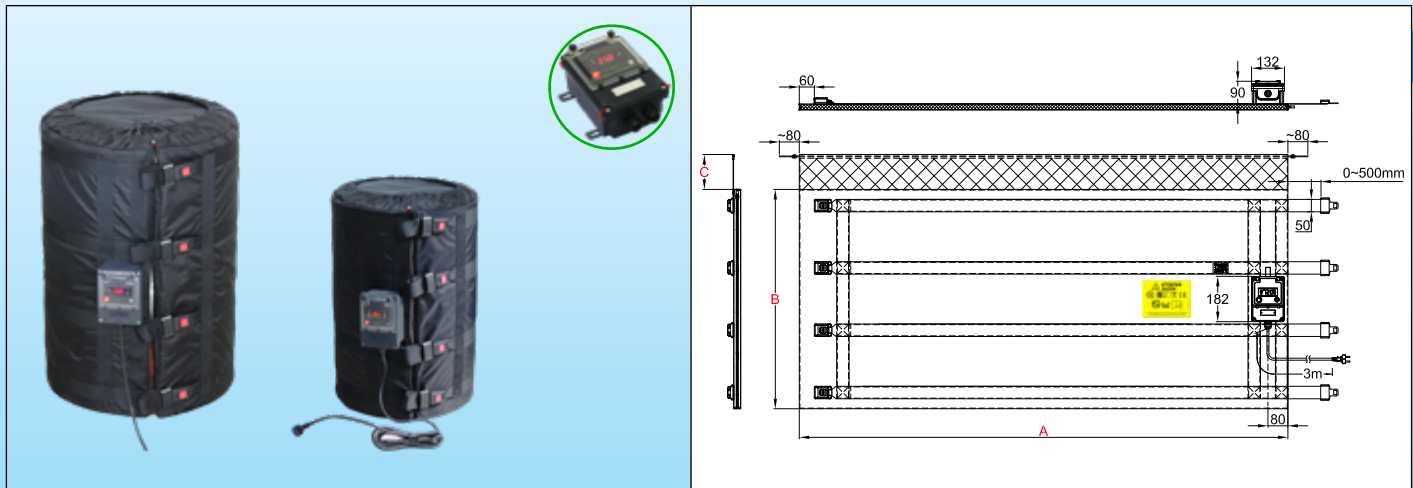

## Main Features

Thanks to its **digital electronic temperature controller**, adjustable up to **120°C**, these flexible jacket heaters are used for antifreeze protection, reheating, temperature stabilization, to reduce viscosity or to melt soaps, animal or vegetable fats, varnishes, oils, food or chemical products.

This series of jacket heaters is the most **universal** solution, with **digital electronic temperature controller** for **heating at a set temperature** glass or plastic containers. They are available for containers of 110L (30 US gallons) and 210L (55US gallons). The jacket heater covers the entire surface and is surmounted by a soft collar "a scarf" preventing it from sliding down. They are made **with three power levels**: (0.05W/cm<sup>2</sup> for temperature up to 50°C, 0.1W/cm<sup>2</sup> for temperature up to 80°C, and 0.135W/cm<sup>2</sup> for temperature up to 110°C. Their thickness of insulation is 20mm. In these models the surface temperature is limited to 135°C. When they are used with an insulated lid and an insulated pedestal, their energetic efficiency can rise 90%.

## Technical characteristics

The heating element of the flexible jacket heater consists of a network of silicone insulated heating wires shielded by a metal braid, taken under a cover sewn in PU and Teflon coated polyester fabric. A 20mm thick, temperature-resistant NBR-PVC foam insulation is inserted between the heating network and the outer wall. This insulating foam has an insulation coefficient (Lambda λ) of 0.039W/m.K, and this makes it possible to divide the energy losses by 3 compared to jacket heaters insulated with mineral wool or carbon fiber felt of the same thickness. Adjustable metal buckles allow quick assembly and disassembly and efficient clamping on the container. Their mechanical strength is exceptional.

### Fabric covering:

- Internal heating face: Teflon coated polyester fabric,
- External side: waterproof PU coated polyester fabric.

### Thermal insulation:

NBR-PVC foam, with closed cells and high temperature resistance, thickness 20mm.

### Heating element:

Silicon insulated heating wire with metal braid providing mechanical protection against puncturing and good grounding.

### Temperature control:

By an electronic temperature controller **with digital display** adjustable up to 120°C, located in a **waterproof** box mounted on the **external surface of the jacket heater**. It controls the temperature by means of a thermistor probe placed on the inner surface of the fabric in contact with the container. This probe has an anticipation loop avoiding overheating. A temperature limiter is incorporated in the heating net to limit the surface temperature to 135°C.

### Connection cable:

Insulated rubber power supply cable, for industrial environments, 3 x 1mm<sup>2</sup> or 3x1.5mm<sup>2</sup> (depending of power) length 3m, Euro plug. UL plug on request.

### Mounting on containers:

These jacket heaters feature nylon straps with quick-release adjustable buckles for adjustment to the diameter of the

# Flexible jacket heaters with **digital display electronic controller**, adjustable up to **120°C**, **surface mounted**, for metal containers



container, and a soft fabric collar without thermal insulation named scarf. This flexible scarf can be used to hold in place an insulating lid in the case of cylindrical containers.

## Options:

- Power supply 110/115V
- Power cord with industrial plug 2-pole + earth 16A CEE (IEC60309)
- Lids and insulating pedestals: see the accessories pages

**Compliance with standards:** CE compliant. TUV certificate for EEC Low Voltage Directive (LVD) and EMC directive 2004/108/EC, and CE marked accordingly.

## Main references (see the technical introduction for the liquids heating time)

References*	Volume, US gallons	Volume, Liters	Dia. (mm ± 12; inch ± 1/2")	Height <b>A</b> (mm/inch)	Flat length <b>B</b> (mm/inch)	Scarf <b>C</b> (mm/inch)	w/cm <sup>2</sup> (W/in <sup>2</sup> )**	Max temp. °C	Watt	Voltage V
9VJAD731558550HG	30	110	460 (18.1)	730 (28.8)	1550 (61)	100 (3.9)	0,05 (0.32)	50	550	220/240
9VJAD881898880HG	55	210	585 (23)	880 (34.6)	1890 (74.4)	100 (3.9)	0,05 (0.32)	50	880	220/240
9VJAD731558A10HG	30	110	460 (18.1)	880 (34.6)	1550 (61)	100 (3.9)	0,1 (0.64)	80	1100	220/240
9VJAD881898A665G	55	210	460 (18.1)	1000 (39.4)	1890 (74.4)	100 (3.9)	0,1 (0.64)	80	1660	220/240
9VJAD731558A155G	30	110	460 (18.1)	880 (34.6)	1550 (61)	100 (3.9)	0,135 (0.86)	110	1500	220/240
9VJAD881898B255G	55	210	460 (18.1)	1000 (39.4)	1890 (74.4)	100 (3.9)	0,135 (0.86)	110	2250	220/240

\* For these products supplied with UL plug and not Euro plug, replace the 15th character by X

Because of permanent improvement of our products, drawings, descriptions, features used on these data sheets are for guidance only and can be modified without prior advice

# Flexible jacket heaters with **digital display electronic controller**, adjustable up to 120°C, **remote wall mounting**, for metal containers



Because of permanent improvement of our products, drawings, descriptions, features used on these data sheets are for guidance only and can be modified without prior advice

Containers material	Maximum temperature limited to :	Tightening	Thermostat	Insulation thickness	Type
Metal	135°C	Nylon straps and metal buckle	Electronic, set point adjustable up to 120°C	20mm	<b>9VJAF</b>

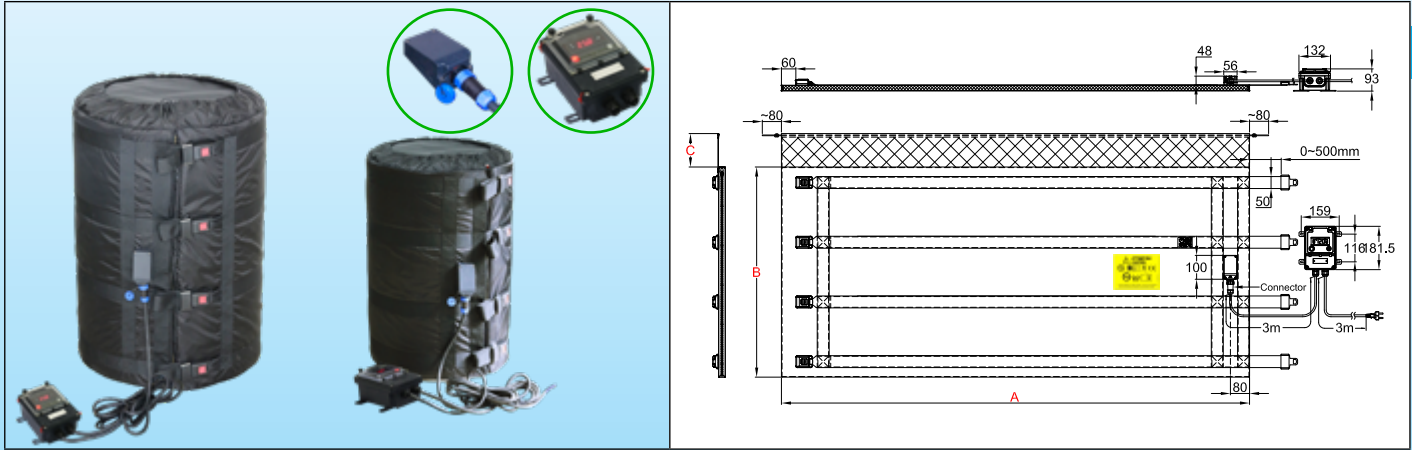

## Main Features

Thanks to its **electronic digital temperature controller**, adjustable up to 120°C, these flexible jacket heaters are used for antifreeze protection, reheating, temperature stabilization, to reduce viscosity or to melt soaps, animal or vegetable fats, varnishes, oils, food or chemical products.

This series of jacket heaters is the most **universal** solution, with **digital electronic temperature controller** for heating at a **set temperature** glass or plastic containers. They are available for containers of 110L (30 US gallons) and 210L (55US gallons). **The wall mounting of the control box, as well as the quick connector ensuring the connection of this box on the jacket heater facilitate industrial use in a fixed working place in a production line.** The jacket heater covers the entire surface and is surmounted by a soft collar "a scarf" preventing it from sliding down. They are made **with three power levels**: (0.05W/cm<sup>2</sup> for temperature up to 50°C, 0.1W/cm<sup>2</sup> for temperature up to 80°C, and 0.135W/cm<sup>2</sup> for temperature up to 110°C. Their thickness of insulation is 20mm. In these models the surface temperature is limited to 135°C. When they are used with an insulated lid and an insulated pedestal, their energetic efficiency can rise 90%.

## Technical characteristics

The heating element of the flexible jacket heater consists of a network of silicone insulated heating wires shielded by a metal braid, taken under a cover sewn in PU and Teflon coated polyester fabric. A 20mm thick, temperature-resistant NBR-PVC foam insulation is inserted between the heating network and the outer wall. This insulating foam has an insulation coefficient (Lambda  $\lambda$ ) of 0.039W/m.K, and this makes it possible to divide the energy losses by 3 compared to jacket heaters insulated with mineral wool or carbon fiber felt of the same thickness. Adjustable metal buckles allow quick assembly and disassembly and efficient clamping on the container. Their mechanical strength is exceptional.

### Fabric covering:

- Internal heating face: Teflon coated polyester fabric,
- External side: waterproof PU coated polyester fabric.

### Thermal insulation:

NBR-PVC foam, with closed cells and high temperature resistance, thickness 20mm.

### Heating element:

Silicon insulated heating wire with metal braid providing mechanical protection against puncturing and good grounding.

### Temperature control:

By electronic controller with digital display, On-Off action, relay output, located in an independent waterproof housing, designed for wall mounting. It is connected to the heating blanket by a cable equipped with a 5-pin waterproof quick connector, facilitating the connection and disconnection with the jacket heater. It controls the temperature by means of a thermistor probe placed on the inner surface of the fabric in contact with the container. This probe has an anticipation loop avoiding overheating. A temperature limiter is incorporated in the heating net to limit the surface temperature to 135°C.

### Connection cable:

Insulated rubber power supply cable, for industrial environments, 3 x 1mm<sup>2</sup> or 3x1.5mm<sup>2</sup> (depending of power) length 3m, Euro plug. UL plug on request.

# Flexible jacket heaters with digital display electronic controller, adjustable up to 120°C, remote wall mounting, for metal containers



## Mounting on containers:

These jacket heaters feature nylon straps with quick-release adjustable buckles for adjustment to the diameter of the container, and a soft fabric collar without thermal insulation named scarf. This flexible scarf can be used to hold in place an insulating lid in the case of cylindrical containers.

## Options:

- Double display electronic temperature controller, Pt100 sensor, ON-OFF action, electromechanical relay power output.
- Double display electronic temperature controller, Pt100 sensor, PID action, solid state relay (SSR) power output.
- Power supply 110/115V
- Power cord with industrial plug 2-pole + earth 16A CEE (IEC60309)
- Lids and insulating pedestals: see the accessories pages.

**Compliance with standards:** CE compliant. TUV certificate for EEC Low Voltage Directive (LVD) and EMC directive 2004/108/EC, and CE marked accordingly.

## Main references (see the technical introduction for the liquids heating time)

References*	Volume, US gallons	Volume, Liters	Dia. (mm ± 12; inch ± ½")	Height A (mm/inch)	Flat length B (mm/inch)	Scarf C (mm/inch)	w/cm <sup>2</sup> (W/in <sup>2</sup> )**	Max temp. °C	Watt	Voltage V
9VJAF731558550HG	30	110	460 (18.1)	730 (28.8)	1550 (61)	100 (3.9)	0,05 (0.32)	50	550	220/240
9VJAF881898880HG	55	210	585 (23)	880 (34.6)	1890 (74.4)	100 (3.9)	0,05 (0.32)	50	880	220/240
9VJAF731558A10HG	30	110	460 (18.1)	880 (34.6)	1550 (61)	100 (3.9)	0,1 (0.64)	80	1100	220/240
9VJAF881898A665G	55	210	460 (18.1)	1000 (39.4)	1890 (74.4)	100 (3.9)	0,1 (0.64)	80	1660	220/240
9VJAF731558A155G	30	110	460 (18.1)	880 (34.6)	1550 (61)	100 (3.9)	0,135 (0.86)	110	1500	220/240
9VJAF881898B255G	55	210	460 (18.1)	1000 (39.4)	1890 (74.4)	100 (3.9)	0,135 (0.86)	110	2250	220/240

\* For these products supplied with UL plug and not Euro plug, replace the 15th character by X.

Because of permanent improvement of our products, drawings, descriptions, features used on these data sheets are for guidance only and can be modified without prior advice



Because of permanent improvement of our products, drawings, descriptions, features used on these data sheets are for guidance only and can be modified without prior advice

# **Jacket heaters with adjustable electronic temperature control for 1000L IBC (Industrial bulk containers)**



## Safety instructions for all industrial jacket heaters described in this catalogue

- Read the user manual before any use
- Protect the power supply circuit by a differential circuit breaker of 20mA sensitivity, with rating adapted to the model that must be connected to it.
- This supply circuit must be carried out by a qualified electrician and according to the local standards in force.
- The earth circuit must be compliant and connected.
- The jacket heater must be disconnected when the container is empty.
- The jacket heater must be disconnected when filling the container.
- The jacket heater must be disconnected during installation or de-installation.
- The jacket heater must be stored in a dry place and protected from rodents and other animals during periods when it is not used.
- In some applications and especially when liquid overflow is possible, it may be necessary to connect the metal containers directly to a grounding conductor.
- The jacket heater must be used in a dry environment.
- Do not cut or punch the surface
- The container must be in communication with the atmospheric pressure to avoid the increase of its internal pressure and its explosion by dilation or boiling of the products which it contains. This setting at atmospheric pressure may for example be performed by unscrewing or removing a plug located in the upper part of the container. The use of a temperature sensor and/or stirrer using this upper orifice for their fastenings must not completely close this orifice.
- These appliances are not suitable for permanent outdoor use, and must be protected from rain, dust and condensation.
- Do not operate above the rated safety temperature (This temperature depends on the heated liquid, and must be checked before connecting the device).
- Use a jacket heater adapted to the size of the container
- The jacket heater must be in contact with the surface of the container to be heated, without superimposing heating parts. The superposition of two heating parts doubles the surface power and can cause melting of the jacket heater and initiate a fire in the most severe cases.
- Position the jacket heater so that it is in contact with the largest possible cylindrical surface of the container.
- These devices are not suitable for use in flammable or explosive areas.



**Jacket heaters for 1000L IBC containers with tubular steel frame. One heating zone.**  
**Miniature electronic thermostat, adjustment by 4-40°C knob, mounted on jacket surface**



Because of permanent improvement of our products, drawings, descriptions, features used on these data sheets are for guidance only and can be modified without prior advice

Containers material	Maximum temperature limited to :	Tightening	Thermostat	Insulation thickness	Type
Plastic with tubular steel frame	65°C	Nylon straps and metal buckle	Electronic, set point adjustable by knob from 4 to 40°C	20mm	<b>9VJDA</b>

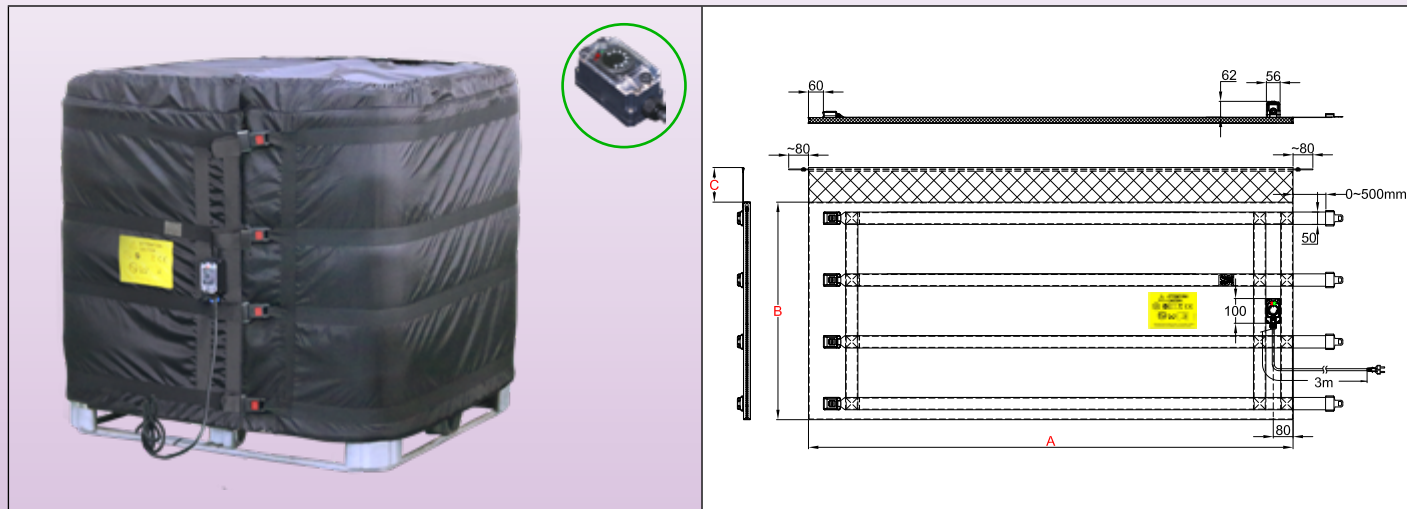

### Main Features

Thanks to its miniature electronic thermostat, adjustable by knob from 4 to 40°C, this series of flexible jacket heaters is mainly used for anti-freeze protection. This serial of flexible jacket heaters is **the most economical solution, with a single temperature control for the entire heating mantle**. It is intended for 1000 liters bulk containers (IBC) of 1m x 1.20m and height 1m. The jacket heater covers the entire surface and is surmounted by a soft collar (Scarf) preventing sliding down. They are achievable with a **single power level: 0.05W/cm<sup>2</sup>**, for temperatures up to 50°C. Their insulation is 20mm thick. Their surface temperature is limited by two limiters at 65°C. When used with a pedestal and an insulating lid (recommended), their energy efficiency can reach 90%.

### Technical characteristics

The heating element of the flexible jacket heater consists of a network of silicone insulated heating wires shielded by a metal braid, taken under a cover sewn in PU and Teflon coated polyester fabric. A 20mm thick, temperature-resistant NBR-PVC foam insulation is inserted between the heating network and the outer wall. This insulating foam has an insulation coefficient (Lambda λ) of 0.039W/m.K, and this makes it possible to divide the energy losses by 3 compared to jacket heaters insulated with mineral wool or carbon fiber felt of the same thickness. Adjustable **metal** buckles allow quick assembly and disassembly and efficient clamping on the container. Their mechanical strength is exceptional.

**Fabric covering:**

- Internal heating face: Teflon coated polyester fabric,
- External side: waterproof PU coated polyester fabric.

**Thermal insulation:**

NBR-PVC foam, with closed cells and high temperature resistance, thickness 20mm.

**Heating element:**

Silicon insulated heating wire with metal braid providing mechanical protection against puncturing and good grounding.

**Temperature control:**

By an electronic thermostat adjustable from 4 to 40°C, located in a **waterproof** box mounted on the **external surface of the jacket heater**. It controls the temperature by means of a thermistor probe placed on the inner surface of the fabric in contact with the container. This probe has an anticipation loop avoiding overheating. Two temperature limiters are incorporated in the heating net to limit the surface temperature to 50°C.

**Connection cable:**

Insulated rubber power supply cable, for industrial environments, 3x1.5mm<sup>2</sup>, length 3m, with Euro plug. UL plug on request.

**Mounting on containers:**

These jacket heaters feature nylon straps with quick-release adjustable buckles and a soft fabric collar without thermal insulation named scarf. This flexible scarf can be used to hold in place a flat insulating lid

**Jacket heaters for 1000L IBC containers with tubular steel frame. One heating zone.**  
**Miniature electronic thermostat, adjustment by 4-40°C knob, mounted on jacket surface**



**Options:**

- Electronic thermostat temperature range -40+40°C
- Power supply 110/115V
- Power cord with industrial plug 2-pole + earth 16A CEE (IEC60309)
- Lids and insulating pedestals: see the accessories pages.

**Compliance with standards:** CE compliant. TUV certificate for EEC Low Voltage Directive (LVD) and EMC directive 2004/108/EC, and CE marked accordingly.

**Main references** (see the technical introduction for the liquids heating time)

References*	Volume, US gallons	Volume, Liters	Dia. (mm ± 12; Inch ± ½")	Height A (mm/inch)	Flat length B (mm/inch)	Scarf C (mm/inch)	w/cm² (W/in²)	Max temp. °C	Watt	Voltage V
9VJDAA0D398B205G	264	1000	1000 x 1200 (39.4 x 47.3)	1000 (39.4)	4390 (172.8)	100 (3.9)	0,05 (0.32)	50	2200	220/240

\* For these products supplied with UL plug and not Euro plug, replace the 15th character by X

Because of permanent improvement of our products, drawings, descriptions, features used on these data sheets are for guidance only and can be modified without prior advice

# Jacket heaters for 1000L IBC containers with tubular steel frame. **One heating zone.** **Digital display** electronic temperature controller, **remote wall mounting**



Because of permanent improvement of our products, drawings, descriptions, features used on these data sheets are for guidance only and can be modified without prior advice

Containers material	Maximum temperature limited to :	Tightening	Thermostat	Insulation thickness	Type
Plastic with tubular steel frame	65°C	Nylon straps and metal buckle	Remote electronic temperature controller	20mm	<b>9VJDF</b>

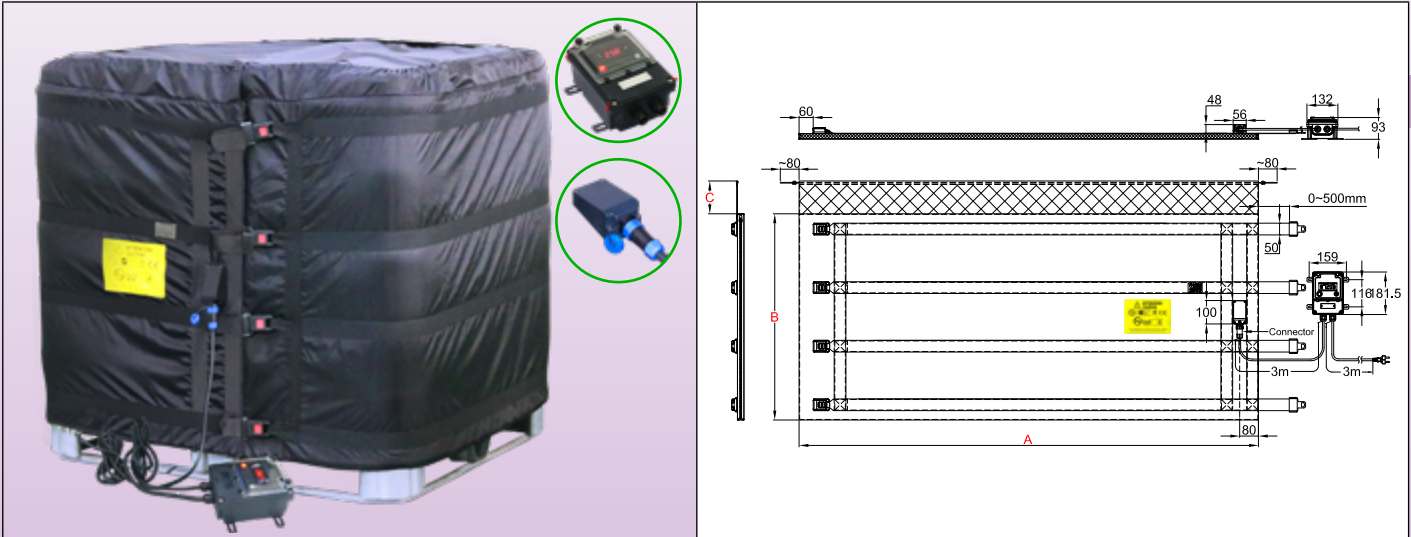

## Main Features

Thanks to its electronic digital temperature controller, adjustable up to 120°C, this series of flexible jacket heaters is mainly used for anti-freeze protection. This type of flexible jacket heaters is **the most professional solution, with a single temperature control for the entire heating mantle**. It is intended for 1000 liters bulk containers (IBC) of 1m x 1.20m and height 1m. **The wall mounting of the control box, as well as the quick connector ensuring the connection of this box on the jacket heater facilitate industrial use in a fixed working place in a production line.** The jacket heater covers the entire surface and is surmounted by a soft collar (Scarf) preventing sliding down. They are achievable with a **single power level: 0.05W/cm<sup>2</sup>**, for temperatures up to 50°C. Their insulation is 20mm thick. Their surface temperature is limited by two limiters at 65°. When used with a pedestal and an insulating lid (recommended), their energy efficiency can reach 90%.

## Technical characteristics

The heating element of the flexible jacket heater consists of a network of silicone insulated heating wires shielded by a metal braid, taken under a cover sewn in PU and Teflon coated polyester fabric. A 20mm thick, temperature-resistant NBR-PVC foam insulation is inserted between the heating network and the outer wall. This insulating foam has an insulation coefficient (Lambda  $\lambda$ ) of 0.039W/m.K, and this makes it possible to divide the energy losses by 3 compared to jacket heaters insulated with mineral wool or carbon fiber felt of the same thickness. Adjustable metal buckles allow quick assembly and disassembly and efficient clamping on the container. Their mechanical strength is exceptional.

### Fabric covering:

- Internal heating face: Teflon coated polyester fabric,
- External side: waterproof PU coated polyester fabric.

### Thermal insulation:

NBR-PVC foam, with closed cells and high temperature resistance, thickness 20mm.

### Heating element:

Silicon insulated heating wire with metal braid providing mechanical protection against puncturing and good grounding.

### Temperature control:

By electronic controller with digital display, On-Off action, relay output, located in an independent **waterproof** housing, **designed for wall mounting**. It is connected to the heating blanket by a cable equipped with a 5-pin **waterproof quick connector**, facilitating the connection and disconnection with the jacket heater. It controls the temperature by means of a thermistor probe placed on the inner surface of the fabric in contact with the container. This probe has an anticipation loop avoiding overheating. Two temperature limiters are incorporated in the heating net to limit the surface temperature to 50°C.

### Connection cable:

Insulated rubber power supply cable, for industrial environments, 3x1.5mm<sup>2</sup>, length 3m, with Euro plug. UL plug on request.

# Jacket heaters for 1000L IBC containers with tubular steel frame. **One heating zone.** **Digital display** electronic temperature controller, **remote wall mounting**



## Mounting on containers:

These jacket heaters feature nylon straps with quick-release adjustable buckles and a soft fabric collar without thermal insulation named scarf. This flexible scarf can be used to hold in place a flat insulating lid

## Options:

- Electronic thermostat temperature range -40+40°C
- Power supply 110/115V
- Power cord with industrial plug 2-pole + earth 16A CEE (IEC60309)
- Lids and insulating pedestals: see the accessories pages.

**Compliance with standards:** CE compliant. TUV certificate for EEC Low Voltage Directive (LVD) and EMC directive 2004/108/EC, and CE marked accordingly.

## Main references (see the technical introduction for the liquids heating time)

References*	Volume, US gallons	Volume, Liters	Dia. (mm ± 12; Inch ± 1/2")	Height <b>A</b> (mm/inch)	Flat length <b>B</b> (mm/inch)	Scarf <b>C</b> (mm/inch)	w/cm <sup>2</sup> (W/in <sup>2</sup> )	Max temp. °C	Watt	Voltage V
9VJDFAD398B205G	264	1000	1000 x 1200 (39.4 x 47.3)	1000 (39.4)	4390 (172.8)	100 (3.9)	0,05 (0.32)	50	2200	220/240

\*For these products supplied with UL plug and not Euro plug, replace the 15th character by X.

Because of permanent improvement of our products, drawings, descriptions, features used on these data sheets are for guidance only and can be modified without prior advice



Because of permanent improvement of our products, drawings, descriptions, features used on these data sheets are for guidance only and can be modified without prior advice

Containers material	Maximum temperature limited to :	Tightening	Thermostat	Insulation thickness	Type
Plastic with tubular steel frame	135°C	Nylon straps and metal buckle	2 Electronic, set point adjustable by knobs from 20 to 125°C	20mm	<b>9VJBE</b>

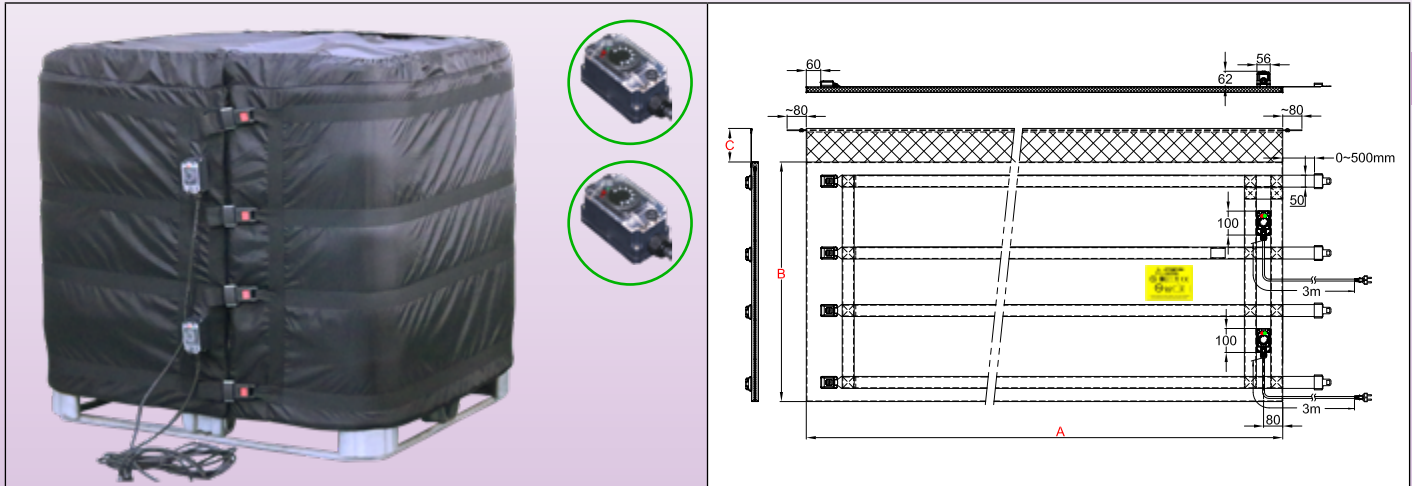

## Main Features

Thanks to its two miniature electronic thermostats, adjustable by knob from 20 to 125°C, this series of flexible jacket heaters with 2 heating zones with 2 independent temperature controls are used for antifreeze protection, reheating, temperature stabilization, to reduce viscosity or to melt soaps, animal or vegetable fats, varnishes, oils, food or chemical products.

This series of jacket heaters is the most economical solution, with for heating at a set temperature 1000 liters bulk containers (IBC) of 1m x 1.20m and height 1m. For heating half empty containers, it is possible to heat only the lower zone. The jacket heater covers the entire surface and is surmounted by a soft collar (Scarf) preventing sliding down. They are made with three power levels: (0.05W/cm<sup>2</sup> for temperature up to 50°C, 0.1W/cm<sup>2</sup> for temperature up to 80°C, and 0.135W/cm<sup>2</sup> for temperature up to 110°C. Their thickness of insulation is 20mm. In these models the surface temperature is limited to 135°C. They can therefore be used on full metal 1000 liters IBC, and provided that the set points of the electronic regulators are set at sufficiently low temperatures, on plastic containers. When they are used with an insulated lid and an insulated pedestal, their energetic efficiency can rise 90%.

## Technical characteristics

The heating element of the flexible jacket heater consists of a network of silicone insulated heating wires shielded by a metal braid, taken under a cover sewn in PU and Teflon coated polyester fabric. A 20mm thick, temperature-resistant NBR-PVC foam insulation is inserted between the heating network and the outer wall. This insulating foam has an insulation coefficient (Lambda λ) of 0.039W/m.K, and this makes it possible to divide the energy losses by 3 compared to jacket heaters insulated with mineral wool or carbon fiber felt of the same thickness. Adjustable metal buckles allow quick assembly and disassembly and efficient clamping on the container. Their mechanical strength is exceptional.

### Fabric covering:

- Internal heating face: Teflon coated polyester fabric,
- External side: waterproof PU coated polyester fabric.

### Thermal insulation:

NBR-PVC foam, with closed cells and high temperature resistance, thickness 20mm.

### Heating element:

Silicon insulated heating wire with metal braid providing mechanical protection against puncturing and good grounding.

### Temperature control:

Each of the 2 heating zones has its own electronic thermostat adjustable from 20 to 125°C, located in a waterproof box mounted on the external surface of the jacket heater. It controls the temperature by means of a thermistor probe placed on the inner surface of the fabric in contact with the container. This probe has an anticipation loop avoiding overheating. Each of the 2 heating zones has also its own temperature limiter, incorporated in the heating net to limit the surface temperature to 135°C.

**Jacket heaters for 1000L IBC containers. Two independent heating zones. 2 Miniature electronic thermostats, adjustment by 20-125°C knobs, mounted on jacket surface**



**Connection cable:**

Each of the 2 heating zones has its own rubber insulated power supply cable, for industrial environments, 3x1.5mm<sup>2</sup>, length 3m, with Euro plug. UL plug on request.

**Mounting on containers:**

These jacket heaters feature nylon straps with quick-release adjustable buckles and a soft fabric collar without thermal insulation named scarf. This flexible scarf can be used to hold in place a flat insulating lid

**Options:**

- Electronic thermostat temperature range -40+40°C, 30-90°C, 30-110°C
- Power supply 110/115V
- Power cord with industrial plug 2-pole + earth 16A CEE (IEC60309)
- Lids and insulating pedestals: see the accessories pages.

**Compliance with standards:** CE compliant. TUV certificate for EEC Low Voltage Directive (LVD) and EMC directive 2004/108/EC, and CE marked accordingly.

**Main reference** (see the technical introduction for the liquids heating time)

References*	Volume, US gallons	Volume, Liters	Dia. (mm ± 12; Inch ± ½")	Height A (mm/inch)	Flat length B (mm/inch)	Scarf C (mm/inch)	w/cm <sup>2</sup> (W/in <sup>2</sup> )**	Max temp. °C	Watt	Voltage V
9VJBEA0D398B205G	264	1000	1000 x 1200 (39.4 x 47.3)	1000 (39.4)	4390 (172.8)	100 (3.9)	0,05 (0.32)	50	2x1100	220/240
9VJBEA0D398D405G	264	1000	1000 x 1200 (39.4 x 47.3)	1000 (39.4)	4390 (172.8)	100 (3.9)	0.1 (0.64)	80	2x2200	220/240
9VJBEA0D398F005G	264	1000	1000 x 1200 (39.4 x 47.3)	1000 (39.4)	4390 (172.8)	100 (3.9)	0.135 (0.87) **	110	2x3000	220/240

\* For these products supplied with UL plug and not Euro plug, replace the 15th character by X.

\*\* Surface load not recommended for direct contact with plastic containers.

Because of permanent improvement of our products, drawings, descriptions, features used on these data sheets are for guidance only and can be modified without prior advice

**Jacket heaters for 1000L IBC containers. Two independent heating zones. 2 digital display electronic temperature controllers, adjustment up to 120°C, mounted on jacket surface**



Because of permanent improvement of our products, drawings, descriptions, features used on these data sheets are for guidance only and can be modified without prior advice

Containers material	Maximum temperature limited to :	Tightening	Thermostat	Insulation thickness	Type
Plastic with tubular steel frame	135°C	Nylon straps and metal buckle	Electronic temperature controllers, set point adjustable up to 120°C	20mm	<b>9VJBD</b>

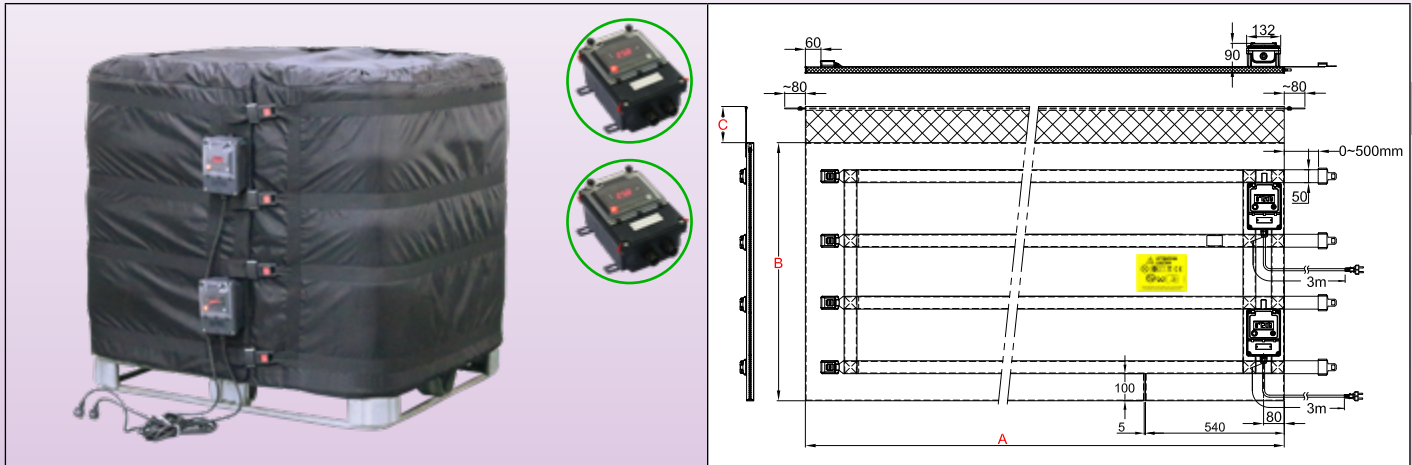

### Main Features

Thanks to its digital display electronic temperature controllers, adjustable up to 120°C, this series of flexible jacket heaters with 2 heating zones with 2 independent temperature controls are used for antifreeze protection, reheating, temperature stabilization, to reduce viscosity or to melt soaps, animal or vegetable fats, varnishes, oils, food or chemical products.

This series of jacket heaters is the most universal solution, with for heating at a set temperature 1000 liters bulk containers (IBC) of 1m x 1.20m and height 1m. For heating half empty containers, it is possible to heat only the lower zone. The jacket heater covers the entire surface and is surmounted by a soft collar (Scarf) preventing sliding down. They are made with three power levels: (0.05W/cm<sup>2</sup> for temperature up to 50°C, 0.1W/cm<sup>2</sup> for temperature up to 80°C, and 0.135W/cm<sup>2</sup> for temperature up to 110°C. Their thickness of insulation is 20mm. In these models the surface temperature is limited to 135°C. They can therefore be used on full metal 1000 liters IBC, and provided that the set points of the electronic regulators are set at sufficiently low temperatures, on plastic containers. When they are used with an insulated lid and an insulated pedestal, their energetic efficiency can rise 90%.

### Technical characteristics

The heating element of the flexible jacket heater consists of a network of silicone insulated heating wires shielded by a metal braid, taken under a cover sewn in PU and Teflon coated polyester fabric. A 20mm thick, temperature-resistant NBR-PVC foam insulation is inserted between the heating network and the outer wall. This insulating foam has an insulation coefficient (Lambda λ) of 0.039W/m.K, and this makes it possible to divide the energy losses by 3 compared to jacket heaters insulated with mineral wool or carbon fiber felt of the same thickness. Adjustable metal buckles allow quick assembly and disassembly and efficient clamping on the container. Their mechanical strength is exceptional.

**Fabric covering:**

- Internal heating face: Teflon coated polyester fabric,
- External side: waterproof PU coated polyester fabric.

**Thermal insulation:**

NBR-PVC foam, with closed cells and high temperature resistance, thickness 20mm.

**Heating element:**

Silicon insulated heating wire with metal braid providing mechanical protection against puncturing and good grounding.

**Temperature control:**

Each of the 2 heating zones has its own electronic temperature controller with digital display adjustable up to 120°C, located in a waterproof box mounted on the external surface of the jacket heater. It controls the temperature by means of a thermistor probe placed on the inner surface of the fabric in contact with the container. This probe has an anticipation loop avoiding overheating. Each of the 2 heating zones has also its own temperature limiter, incorporated in the heating net to limit the surface temperature to 135°C.

**Connection cable:**

Each of the 2 heating zones has its own rubber insulated power supply cable, for industrial environments, 3x1.5mm<sup>2</sup>, length 3m, with Euro plug. UL plug on request.

**Jacket heaters for 1000L IBC containers. Two independent heating zones. 2 digital display electronic temperature controllers, adjustment up to 120°C, mounted on jacket surface**



**Mounting on containers:**

These jacket heaters feature nylon straps with quick-release adjustable buckles and a soft fabric collar without thermal insulation named scarf. This flexible scarf can be used to hold in place a flat insulating lid

**Options:**

- Power supply 110/115V
- Power cord with industrial plug 2-pole + earth 16A CEE (IEC60309)
- Lids and insulating pedestals: see the accessories pages.

**Compliance with standards:** CE compliant. TUV certificate for EEC Low Voltage Directive (LVD) and EMC directive 2004/108/EC, and CE marked accordingly.

**Main references** (see the technical introduction for the liquids heating time)

References*	Volume, US gallons	Volume, Liters	Dia. (mm ± 12; Inch ± ½")	Height A (mm/inch)	Flat length B (mm/inch)	Scarf C (mm/inch)	w/cm <sup>2</sup> (W/in <sup>2</sup> )**	Max temp. °C	Watt	Voltage V
9VJBDA0D398B205G	264	1000	1000 x 1200 (39.4 x 47.3)	1000 (39.4)	4390 (172.8)	100 (3.9)	0,05 (0.32)	50	2x1100	220/240
9VJBDA0D398D405G	264	1000	1000 x 1200 (39.4 x 47.3)	1000 (39.4)	4390 (172.8)	100 (3.9)	0.1 (0.64)	80	2x2200	220/240
9VJBDA0D398F005G	264	1000	1000 x 1200 (39.4 x 47.3)	1000 (39.4)	4390 (172.8)	100 (3.9)	0.135 (0.87) **	110	2x3000	220/240

\* For these products supplied with UL plug and not Euro plug, replace the 15th character by X.

\*\* Surface load not recommended for direct contact with plastic containers

Because of permanent improvement of our products, drawings, descriptions, features used on these data sheets are for guidance only and can be modified without prior advice



**Jacket heaters for 1000L IBC containers. Two independent heating zones. 2 digital display electronic temperature controllers, adjustment up to 120°C, remote wall mounting**



Because of permanent improvement of our products, drawings, descriptions, features used on these data sheets are for guidance only and can be modified without prior advice

Containers material	Maximum temperature limited to :	Tightening	Thermostat	Insulation thickness	Type
Plastic with tubular steel frame	135°C	Nylon straps and metal buckle	Electronic temperature controllers, set point adjustable up to 120°C	20mm	<b>9VJBF</b>

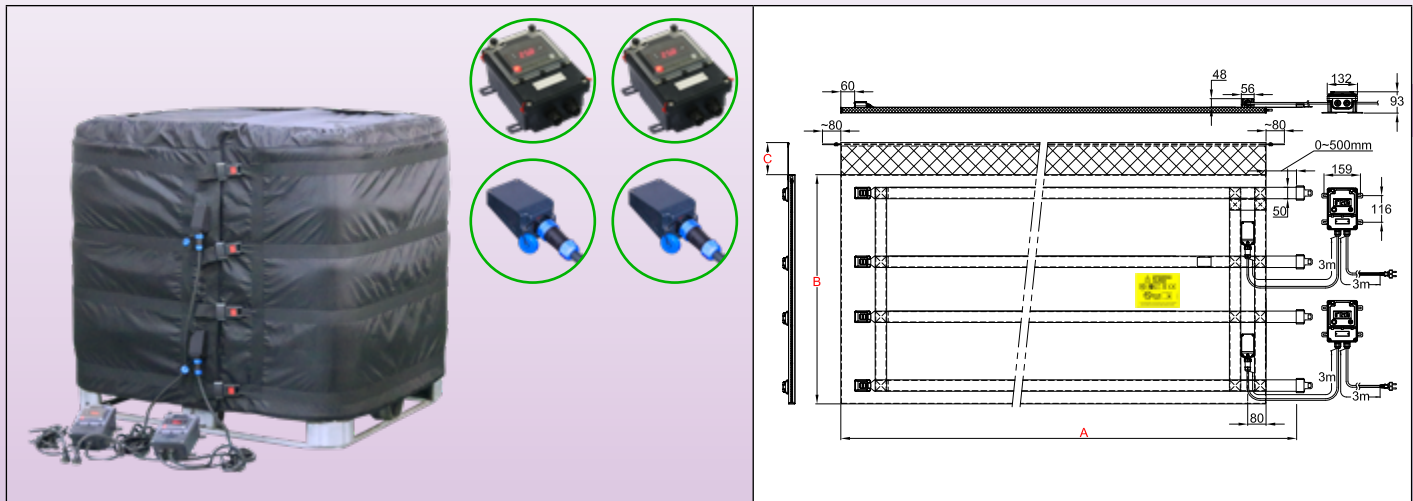

### Main Features

Thanks to its digital display electronic temperature controllers, adjustable up to 120°C, this series of flexible jacket heaters with 2 heating zones with 2 independent temperature controls are used for antifreeze protection, reheating, temperature stabilization, to reduce viscosity or to melt soaps, animal or vegetable fats, varnishes, oils, food or chemical products.

This series of jacket heaters is the most universal solution, with for heating at a set temperature 1000 liters bulk containers (IBC) of 1m x 1.20m and height 1m. The wall mounting of the control box, as well as the quick connector ensuring the connection of this box on the jacket heater facilitate industrial use in a fixed working place in a production line. For heating half empty containers, it is possible to heat only the lower zone. The jacket heater covers the entire surface and is surmounted by a soft collar (Scarf) preventing sliding down. They are made with three power levels: (0.05W/cm<sup>2</sup> for temperature up to 50°C, 0.1W/cm<sup>2</sup> for temperature up to 80°C, and 0.135W/cm<sup>2</sup> for temperature up to 110°C. Their thickness of insulation is 20mm. In these models the surface temperature is limited to 135°C. They can therefore be used on full metal 1000 liters IBC, and provided that the set points of the electronic regulators are set at sufficiently low temperatures, on plastic containers. When they are used with an insulated lid and an insulated pedestal, their energetic efficiency can rise 90%.

### Technical characteristics

The heating element of the flexible jacket heater consists of a network of silicone insulated heating wires shielded by a metal braid, taken under a cover sewn in PU and Teflon coated polyester fabric. A 20mm thick, temperature-resistant NBR-PVC foam insulation is inserted between the heating network and the outer wall. This insulating foam has an insulation coefficient (Lambda λ) of 0.039W/m.K, and this makes it possible to divide the energy losses by 3 compared to jacket heaters insulated with mineral wool or carbon fiber felt of the same thickness. Adjustable metal buckles allow quick assembly and disassembly and efficient clamping on the container. Their mechanical strength is exceptional.

**Fabric covering:**

- Internal heating face: Teflon coated polyester fabric,
- External side: waterproof PU coated polyester fabric.

**Thermal insulation:**

NBR-PVC foam, with closed cells and high temperature resistance, thickness 20mm.

**Heating element:**

Silicon insulated heating wire with metal braid providing mechanical protection against puncturing and good grounding.

**Temperature control:**

Each of the 2 heating zones has its own electronic controller with digital display, On-Off action, relay output, located in an independent waterproof housing, designed for wall mounting. It is connected to the heating blanket by a cable equipped with a 5-pin waterproof quick connector, facilitating the connection and disconnection with the jacket heater. It controls the temperature by means of a thermistor probe placed on the inner surface of the fabric in contact with the container. This probe has an anticipation loop avoiding overheating. Each of the 2 heating zones has also its own temperature limiter, incorporated in the heating net to limit the surface temperature to 135°C.

**Jacket heaters for 1000L IBC containers. Two independent heating zones. 2 digital display electronic temperature controllers, adjustment up to 120°C, remote wall mounting**



**Connection cable:**

Each of the 2 heating zones has its own rubber insulated power supply cable, for industrial environments, 3x1.5mm<sup>2</sup>, length 3m, with Euro plug. UL plug on request.

**Mounting on containers:**

These jacket heaters feature nylon straps with quick-release adjustable buckles and a soft fabric collar without thermal insulation named scarf. This flexible scarf can be used to hold in place a flat insulating lid

**Options:**

- Double display electronic temperature controller, Pt100 sensor, ON-OFF action, electromechanical relay power output.
- Double display electronic temperature controller, Pt100 sensor, PID action, solid state relay (SSR) power output.
- Power supply 110/115V
- Power cord with industrial plug 2-pole + earth 16A CEE (IEC60309)
- Lids and insulating pedestals: see the accessories pages.

**Compliance with standards:** CE compliant. TUV certificate for EEC Low Voltage Directive (LVD) and EMC directive 2004/108/EC, and CE marked accordingly.

**Main references** (see the technical introduction for the liquids heating time)

References*	Volume, US gallons	Volume, Liters	Dia. (mm ± 12; Inch ± 1/2")	Height A (mm/inch)	Flat length B (mm/inch)	Scarf C (mm/inch)	w/cm <sup>2</sup> (W/in <sup>2</sup> )	Max temp. °C	Watt	Voltage V
9VJBFA0D398B205G	264	1000	1000 x 1200 (39.4 x 47.3)	1000 (39.4)	4390 (172.8)	100 (3.9)	0,05 (0.32)	50	2x1100	220/240
9VJBFA0D398D405G	264	1000	1000 x 1200 (39.4 x 47.3)	1000 (39.4)	4390 (172.8)	100 (3.9)	0.1 (0.64)	80	2x2200	220/240
9VJBFA0D398F005G	264	1000	1000 x 1200 (39.4 x 47.3)	1000 (39.4)	4390 (172.8)	100 (3.9)	0.135 (0.87) **	110	2x3000	220/240

\* For these products supplied with UL plug and not Euro plug, replace the 15th character by X.

\*\* Surface load not recommended for direct contact with plastic containers.

Because of permanent improvement of our products, drawings, descriptions, features used on these data sheets are for guidance only and can be modified without prior advice



Because of permanent improvement of our products, drawings, descriptions, features used on these data sheets are for guidance only and can be modified without prior advice



Because of permanent improvement of our products, drawings, descriptions, features used on these data sheets are for guidance only and can be modified without prior advice



Because of permanent improvement of our products, drawings, descriptions, features used on these data sheets are for guidance only and can be modified without prior advice

# Complementary insulation accessories



Because of permanent improvement of our products, drawings, descriptions, features used on these data sheets are for guidance only and can be modified without prior advice

# Insulation lids (without heating), with or without orifices for stirrers and temperature sensors



Because of permanent improvement of our products, drawings, descriptions, features used on these data sheets are for guidance only and can be modified without prior advice

Model	Insulation thickness	Protective cover fabric	Type
Insulating lid	20mm	PA with PU waterproof internal layer	<b>9V2C</b>

## Main Features

These insulating lids make it possible to limit the heat losses of the containers to the outside as much as possible, and thus either to reduce the power required to protect them against frost or to heat them with an equal power and significantly reduce the heating time required for reach the desired temperature.

They use the same PA66 fabric with PU sealing layer, and the same insulating foam as the jacket heaters. They are made in 20mm thickness only.

Insulating lids for circular containers are designed to be held in place by the jacket heater scarf, which must be closed over them.

These lids are available in two versions: with or without a hole at the same place than the filling cap of the container.

This hole can be used for filling, or for accessories like temperature sensor, stirrer or additional immersion heater.

The heating lids for bulk containers of 1000 liters (IBC) includes a skirt which covers the upper part of the heating mantle on 200mm, in order to limit the heat losses at this level as much as possible.

**Options:** other position and diameter for the filling hole.

Picture	Drawing	Description	Reference
		Dia. 280mm lid for 18/20L (5 gallons) and 23/25L (6 gallons) <b>without</b> filling hole	9V2CP62800000000
		Dia. 280mm lid for 18/20L (5 gallons) and 23/25L (6 gallons) <b>with central</b> filling hole dia 130mm	9V2CQ6280000A300
		Dia. 280mm lid for 23/25L (6 gallons) <b>with tangential</b> filling hole dia. 60mm	9V2CR62800006000
		Dia. 410mm lid for 60L (15 gallons) <b>without</b> filling hole	9V2CP64100000000

# Insulation lids (without heating), with or without orifices for stirrers and temperature sensors



Picture	Drawing	Description	Reference
		Dia. 410mm lid for 60L (15 gallons) <b>with central</b> filling hole dia. 280mm	9V2CQ6410000B800
		Dia. 460mm lid for 110L (30 gallons) <b>without</b> filling hole	9V2CP64600000000
		Dia. 460mm lid for 110L (30 gallons) <b>with tangential</b> filling hole dia. 80mm	9V2CR64600008000
		Dia. 580mm lid for 210L (55 gallons) <b>without</b> filling hole	9V2CP65800000000
		Dia. 580mm lid for 210L (55 gallons) <b>with central</b> filling hole dia. 80mm	9V2CQ65800008000
		Dia. 580mm lid for 210L (55 gallons) <b>with tangential</b> filling hole dia. 80mm	9V2CR65800008000



Because of permanent improvement of our products, drawings, descriptions, features used on these data sheets are for guidance only and can be modified without prior advice



# Insulation lids (without heating), with or without orifices for stirrers and temperature sensors

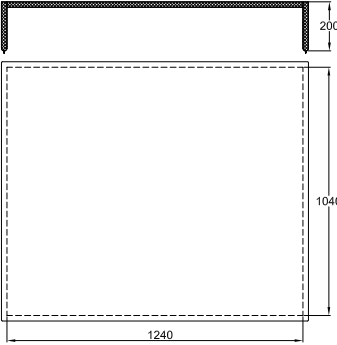

Because of permanent improvement of our products, drawings, descriptions, features used on these data sheets are for guidance only and can be modified without prior advice

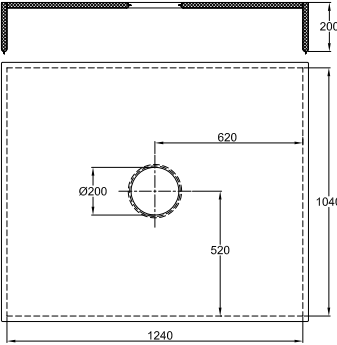
Picture	Drawing	Description	Reference
		<p>1.2 x 1m lid for 1000L IBC, with 200mm skirt, <b>without</b> filling hole</p>	<p>9V2CP61001200020</p>
		<p>1.2 x 1m lid for 1000L IBC, with 200mm skirt, <b>with central</b> filling hole dia. 100mm</p>	<p>9V2CP6100120A020</p>

# Insulation pedestals (without heating)



Model	Insulation thickness	Protective cover fabric	Type
Insulating pedestal	20mm (40mm for 1000L IBC)	No	<b>9V2E</b>

## Main Features





These insulating pedestals make it possible to limit the heat losses of the containers to the outside as much as possible, and thus either to reduce the power required to protect them against frost or to heat them with an equal power and significantly reduce the heating time required for reach the desired temperature.

They feature a rigid stainless steel structure, designed to support the weight of the container and the same insulating foam as the jacket heaters. They are made in 20mm insulation thickness, excepted for the 1000L IBC, made in 40mm.

Insulation foam is not protected by fabric and is easily replacable.

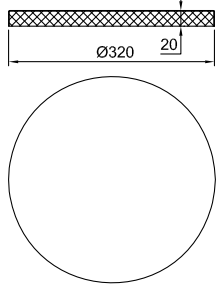
The insulating bases for the 1000 liters IBC comprise a flexible scarf intended to cover the pallet sides or the perforated metal structure of the lower part of these containers, in order to limit as much as possible the heat losses at this level.

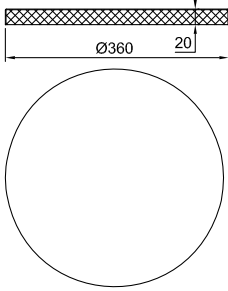
The insulating bases of diameter 460mm and more and those of 1000 liters IBC can be split into 4 parts to facilitate their transport.

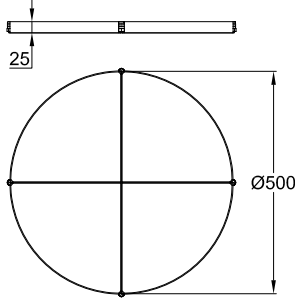
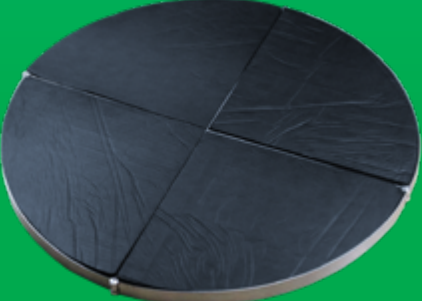
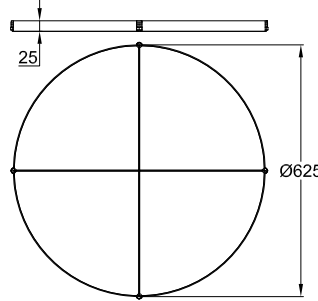
Picture	Drawing	Description	Reference
		Dia. 320mm pedestal for 18/20L (5 gallons) and 20/25L (6 gallons)	9V2EP4320
		Dia. 450mm pedestal for 50/55L (15 gallons)	9V2EP450
		Dia. 500mm pedestal for 110L (30 gallons)	9V2EP4500
		Dia. 620mm pedestal for 210L (55 gallons)	9V2EP420

Because of permanent improvement of our products, drawings, descriptions, features used on these data sheets are for guidance only and can be modified without prior advice

# Insulation pedestals (without heating)



Because of permanent improvement of our products, drawings, descriptions, features used on these data sheets are for guidance only and can be modified without prior advice

Picture	Drawing	Description	Reference
		<p>1240 x 1040 x40mm pedestal for 1000 liters IBC, with removable insulating scarf with strap and buckle</p>	<p>9V2EP71041240020</p>









# Insulated jackets (without heating)

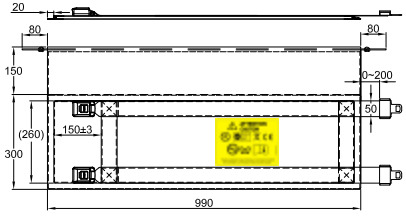

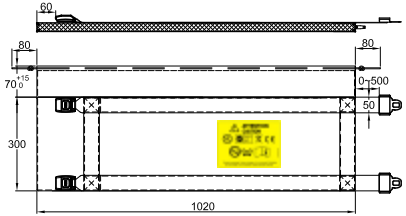
Model	Insulation thickness	Protective cover fabric	Type
Insulated jacket	20mm	PA with PU waterproof internal layer	<b>9V2D</b>

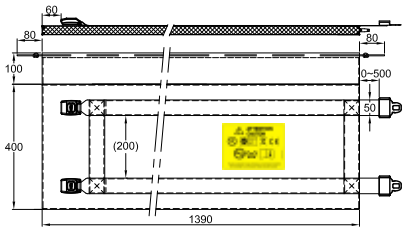
## Main Features

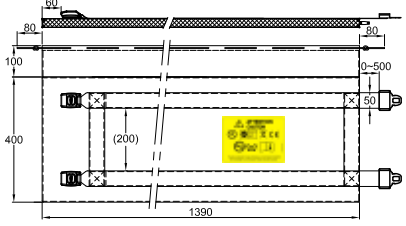
These insulating jackets thermally isolate tanks from their environment. They limit as much as possible the thermal losses of the containers towards the outside. They have straps, metal buckles and scarf identical to the heated models. They can be used to keep containers warm, to protect them from weak frosts, or to cover a tank heated by another system (induction, silicone heating belt, heating base, thermal fluid circulation).

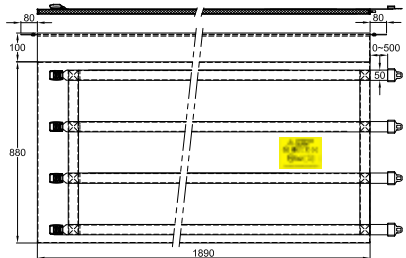
Picture	Drawing	Description	Reference
		Height 300mm, dia. 280mm for 18/20L (5 gallons)	9V2D6030095
		Height 300mm, dia. 280mm for 23/25L (6 gallons)	9V2D6030102
		Height 400mm, dia. 410mm for 60L (15 gallons)	9V2D6040139
		Height 730mm, dia. 460mm for 110L (30 gallons)	9V2D6073155
		Height 880mm dia. 585mm for 210L (55 gallons)	9V2D6088189

Because of permanent improvement of our products, drawings, descriptions, features used on these data sheets are for guidance only and can be modified without prior advice



## Insulated jackets (without heating)

Because of permanent improvement of our products, drawings, descriptions, features used on these data sheets are for guidance only and can be modified without prior advice

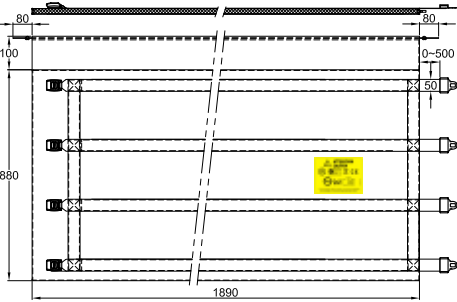
Picture	Drawing	Description	Reference
		Height 1m with 1.2 x 1m base for 1000L IBC.	9V2D6100439



Because of permanent improvement of our products, drawings, descriptions, features used on these data sheets are for guidance only and can be modified without prior advice



Because of permanent improvement of our products, drawings, descriptions, features used on these data sheets are for guidance only and can be modified without prior advice

# Complementary heating accessories



Because of permanent improvement of our products, drawings, descriptions, features used on these data sheets are for guidance only and can be modified without prior advice



# Insulation jackets with heat exchanger tubular circuit (heating or cooling)









Because of permanent improvement of our products, drawings, descriptions, features used on these data sheets are for guidance only and can be modified without prior advice

Model	Insulation thickness	Protective cover fabric	Type
Tubular heat exchanger jacket	20mm	PA with PU waterproof internal layer	<b>9V3</b>

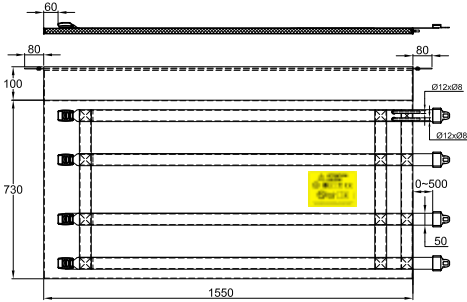
## Main Features

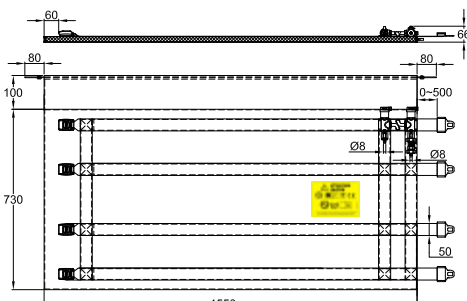

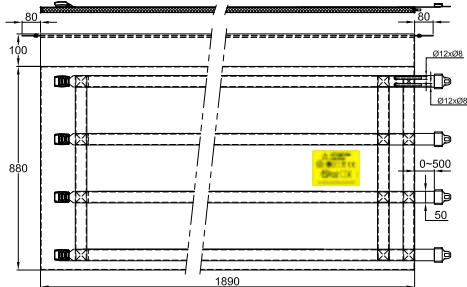
These insulating jackets with tubular exchanger circuit can maintain temperature, protect from frost, heat or cool containers. On their surface in contact with the container, is built a network of flexible silicone tubes in which the heating or cooling fluid can circulate. They are to be connected to an external power source: electric heater, central heating circuit, heat pump, boiler, solar heating, cooling circuit. The maximum allowable pressure is 0.15MPa at 100°C, and the maximum temperature they can withstand is 120°C. The heat transfer fluid is connected to two valves equipped with automatic air traps. We recommend the use of a flow sensor because the compression of the internal tubes by too tight tightening of the straps can restrict or even stop the circulation of heat transfer fluid.

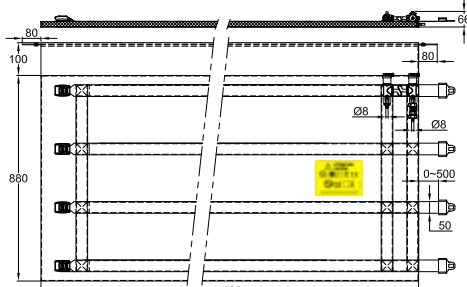
**Option:** version with R36 flow switch, 3/4" thread, 1A breaking capacity. This model has a pressure relief valve set at 0.2MPa

Picture	Drawing	Description	Reference
		Jacket heat exchanger for 110L (30 gallons).	9V314173155N20
		Jacket heat exchanger for 110L (30 gallons). With flow switch and overpressure valve.	9V314173155AVF
		Jacket heat exchanger for 210L (55 gallons).	9V314188189M20
		Jacket heat exchanger for 210L (55 gallons). With flow switch and overpressure valve.	9V314188189AVF

# Insulation jackets with heat exchanger tubular circuit (heating or cooling)

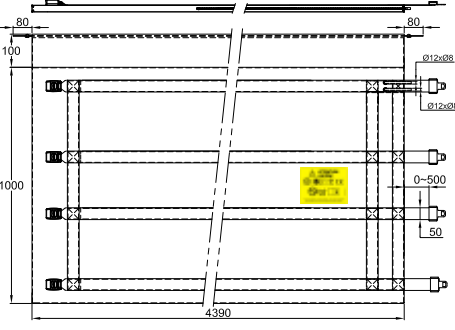

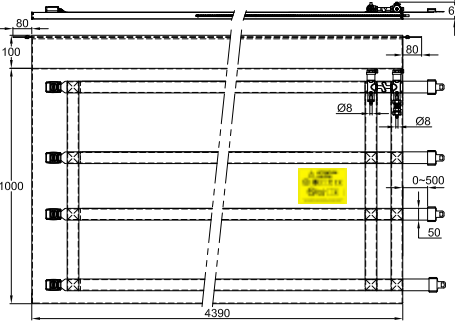
Picture	Drawing	Description	Reference
		<p>Jacket heat exchanger for 1000L IBC, (2 circuits).</p>	<p>9V3142A0439N20</p>
		<p>Jacket heat exchanger for 1000L IBC, (2 circuits). <b>With flow switch and overpressure valve.</b></p>	<p>9V3142A0439AVF</p>

Because of permanent improvement of our products, drawings, descriptions, features used on these data sheets are for guidance only and can be modified without prior advice



## Base heater for 55 gallons metal drum

Heating surface	Power	Enclosure	Ingress protection	Temperature control	Type
Dia. 560mm	1000W	304 Stainless steel	IP69K	10-150°C thermostat	<b>9V4</b>

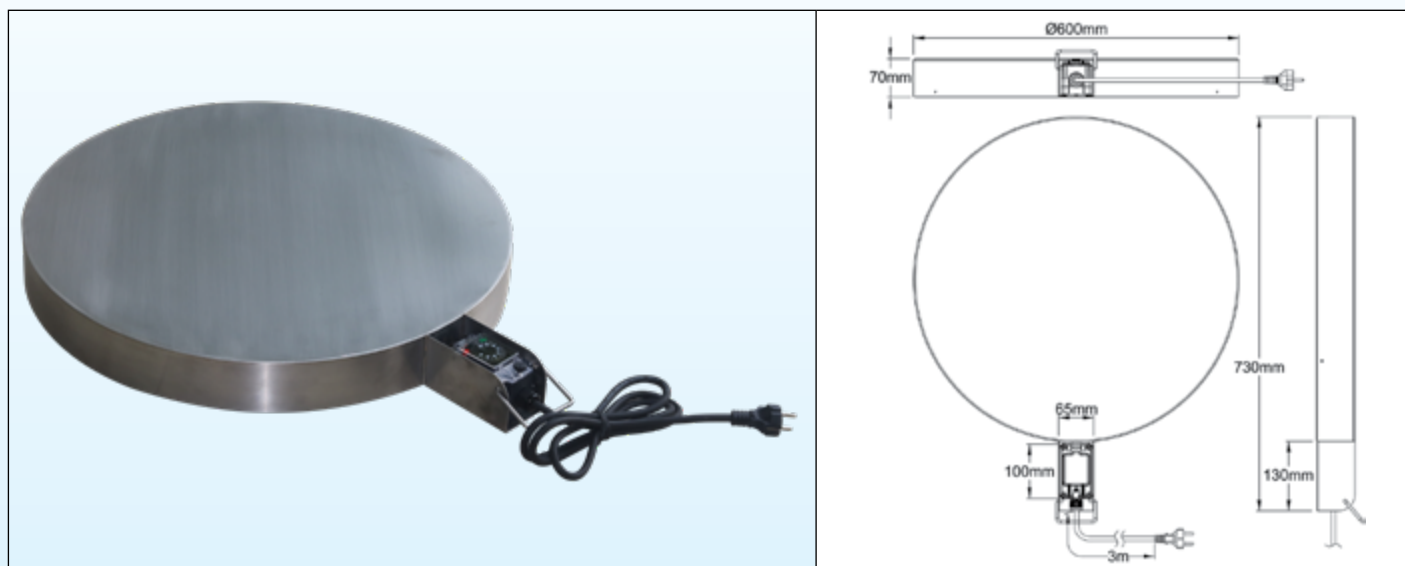

### Main Features

These heaters are used to heat the 200-220 liters (55 US gallons, 45 Imperial Gallons) drums and their lower size versions. Completely made of 304 stainless steel, 1.2 and 2mm thick, resistant to high pressure hot water jet washing, **they can withstand industrial environment, food and chemical applications.** They are not usable in explosive areas. The drum simply needs to be put on these pedestals. The surface load of the heating element is limited to a safe value of 0.5W/cm<sup>2</sup> and the surface temperature is limited to 150°C. They can be used alone in reheating, with or without insulating jacket, or in addition to jacket heaters or heating belts, and in the latter case, they greatly reduce the heating time. As for all heaters for containers and tanks, it is mandatory to keep a connection to atmospheric pressure to avoid an internal overpressure which could burst the barrel. They come standard with 3 x1mm<sup>2</sup> rubber insulated cable, for industrial applications.

**Heating surface:** 3.5mm thick silicone flat element vulcanized under the upper surface and covering the entire 600mm diameter surface. This technique provides a uniform temperature.

**Base:** 304 stainless steel, 600mm diameter, height 70mm, TIG welded.

**Control box:** 56mm x 63mm, height 100mm in PA66 reinforced fiberglass, with waterproof and sealable window. This control box is protected from violent shocks by a stainless-steel envelope. It has a handle for easy handling.

**Ingress protection class:** IP69K

**Temperature control:** By bulb and capillary thermostat with 10-150°C adjustment range. Other temperature ranges 4-40°C, (39-104°F) 30-90°C (86-,194°F) 30-110°C (86-230°F) are available in option. Access to the thermostat setting is possible opening the window.

**Cable gland:** M20 in PA66.

**Connection cable:** Rubber insulated, for industrial environments, 3 x 1mm<sup>2</sup>, length 3m, with Euro plug or UL plug.

**Surface load:** 0.5 W/cm<sup>2</sup>

**Supply voltage:** 230V (110V on request)

**Standard equipment:** Green and red pilot lights, indicating power on and operation of the heater

**Accessories:** Insulating Jackets

**Standards:** Built in accordance with applicable European standards (CE marking)

**Instructions for use:** Observe the instruction manual enclosed with the device.

### Main part numbers (°C printed knob) \*

With 10-150°C (50-300°F), thermostat with 3 meters cord with Euro plug	With 10-150°C (50-300°F), thermostat with 3 meters cord with UL plug
9V46004A0088C3E	9V46004A0088C3U

\* °F printed knob: replace C by F in the part number

# Immersion heater for 1000 liters IBC



Immersion length	Power	Enclosure	Safety	Temperature control	Type
800mm	3000W	Stainless steel, IP54 or IP69K	Dry-run safety	30-90°C thermostat	<b>9SWR2</b>

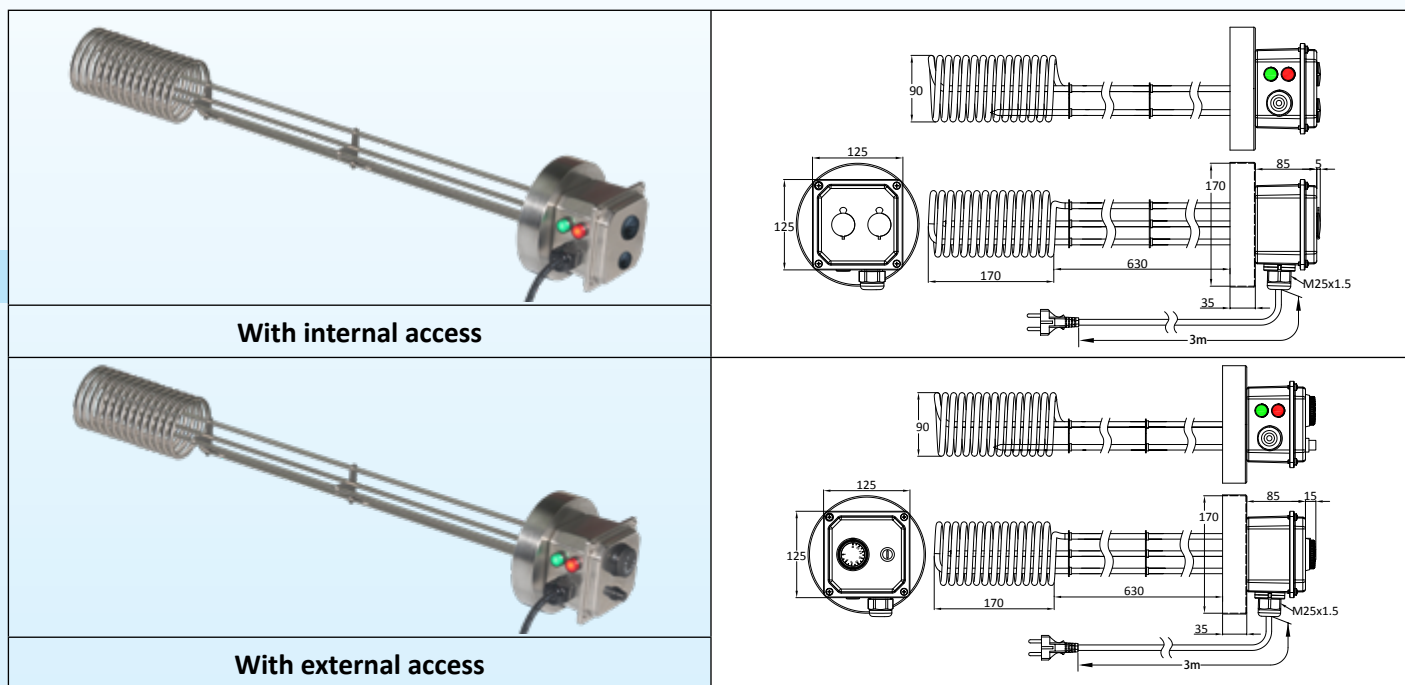

## Main Features

These immersion heaters are mounted on the filling hole of the bulk containers of 1000 liters or more. They simply land on this hole, thanks to a stainless steel cup that covers the thread, while maintaining a connection to atmospheric pressure. Their long non-heating part makes it possible to position the heating coil at the bottom of the container. The surface load of the heating element is  $3\text{W}/\text{cm}^2$ , so that it can be used in aqueous liquids as well as in oils and greases. The stainless steel construction of the housing and of the heating element allows use in industrial and food processing environments. In the internal access models the IP69K ingress protection allows the washing with hot water under pressure. The temperature control is done in the center of the heating coil. A safety is installed on the top of the coil, to automatically turn off the heating when the decrease in the level of the heated product puts the coil in contact with the air.

These immersion heaters can be used alone in reheating, with or without insulating jacket, or in addition to heating jackets, in the latter case, they greatly reduce the heating time.

**Fitting material:** 304 stainless steel cup, dia. 170mm

**Enclosure:** 125mm x 125mm, 85mm height, 304 stainless steel. Silicone gasket. Stainless steel cover screws.

**Ingress protection class with outside access:** IP54

**Ingress protection class with inside access:** IP69K

**Temperature control:** by 30-90°C (85-195°F) bulb and capillary thermostat. Other temperature ranges available. See options hereunder.

**Dry run safety:** By manual reset bulb and capillary thermostat, fail safe, controlling the heating element surface temperature

**Cable gland:** M25, PA66.

**Thermowell:** Two thermowells in AISI304, dia.10mm x 8.4mm for temperature control and dry run safety.

**Power supply connection:** Rubber insulated cord,  $3 \times 1.5\text{mm}^2$ , with euro plug. UI plug on request.

**Immersed zone:** 800mm.

**Surface load:**  $3\text{ W}/\text{cm}^2$ , others values on request.

**Voltage:** Single pole 230V

**Standard equipment:**

- Adjustable thermostat
- Large size (dia. 16mm) green and red LED pilot lights, on the enclosure side
- Dry run manual reset safety: preset at 100°C (212°F).

Because of permanent improvement of our products, drawings, descriptions, features used on these data sheets are for guidance only and can be modified without prior advice



Because of permanent improvement of our products, drawings, descriptions, features used on these data sheets are for guidance only and can be modified without prior advice

## Variants on request:

- Internal thermostat adjustment and manual reset access under screwed M25 cap.
- Thermostat ranges 4-40°C (40-105°F), 0-60°C (30-140°F) or 30-110°C (85-230°F)
- Other dry-run safety temperature setting.

## Main references

With 30-90°C (85-195°F) thermostat <b>external knob</b> , and <b>external</b> manual reset at 100°C (212°F)	With 30-90°C (85-195°F) thermostat <b>internal knob</b> , and <b>internal</b> manual reset at 100°C (212°F)
9SWR2JRT0302680N	9SWR2JRS0302680N

UL plug: replace JRT by JRS



Because of permanent improvement of our products, drawings, descriptions, features used on these data sheets are for guidance only and can be modified without prior advice



Because of permanent improvement of our products, drawings, descriptions, features used on these data sheets are for guidance only and can be modified without prior advice

# Temperature controls and temperature homogenization



Because of permanent improvement of our products, drawings, descriptions, features used on these data sheets are for guidance only and can be modified without prior advice



# Stirrer speed controller with IP65 enclosure and compact full stainless steel stirrer for drums and IBC



Because of permanent improvement of our products, drawings, descriptions, features used on these data sheets are for guidance only and can be modified without prior advice

Power	Assembly	Immersed length	Type
60W, 12VDC	- On drums with 2" threaded filling hole - On IBC (need to drill hole on the plastic cap)	350mm	<b>Y8WTZ, 9H060</b>

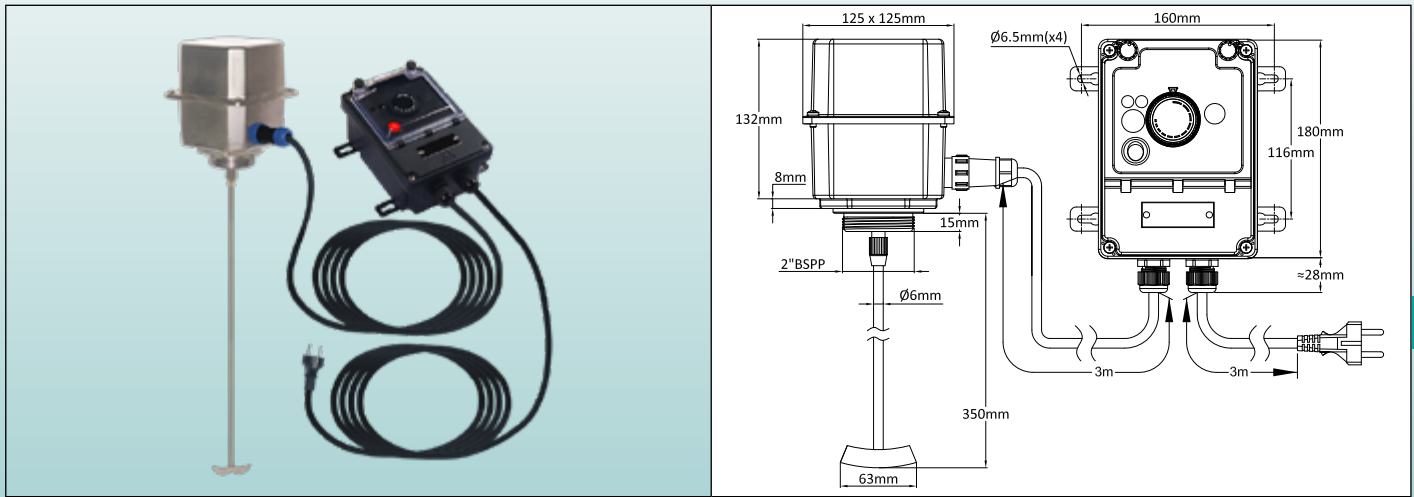

## Main Features

Reheating by jacket heaters of barrels and bulk container type IBC is often slowed by the duration of temperature homogenization, when low-viscosity or low thermal conductivity fluids are used. Deviations of more than 20°C are very often found during heating between the different areas of these containers. The use of a stirrer makes it possible to shorten the reheating time by increasing the speed of the heat transfer at the walls and by equalizing the temperature. This stirrer is screwed onto the 2" threaded filling port of the 30-gallon (100-liter) and 55-gallon (220-liter) metal drums. In the case of bulk containers (IBC), whose filling orifice comprises a plastic cap of variable size according to the manufacturers (100 to 150mm), it is necessary to make a hole of 60mm in this cap and to tighten the stirrer in this hole by a locknut.

Adjustment of its rotation speed is achieved by a low voltage DC supply. This power supply is located in a remote box, connected by a 3m cable equipped with a quick connector.

The rotation speed must be adapted to the viscosity of the fluid. We recommend using this stirrer only when the temperature of the heated fluid is 10 to 20°C below the chosen reheating temperature. The stirrer should not be run in frozen or too viscous products as this will trip the fusible overcurrent protection system.



Stirrers come in two versions: with and without built-in temperature sensor. The temperature sensor allows to check the temperature at the center of the heated product.

The shaft of the stirrer can be disassembled for replacement or to be shortened.

Picture	Drawing	Description
		60 Watts 12V DC Stirrer with 125mm x 125mm stainless steel case, 2" fitting and 350mm shaft, <b>without temperature sensor.</b>
		Reference
		9H0601252035001

# Stirrer speed controller with IP65 enclosure and compact full stainless steel stirrer for drums and IBC

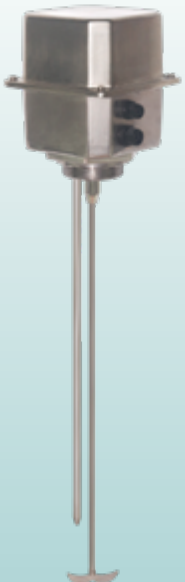
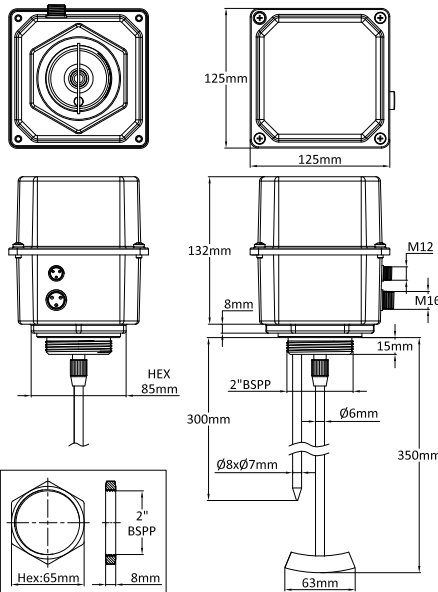

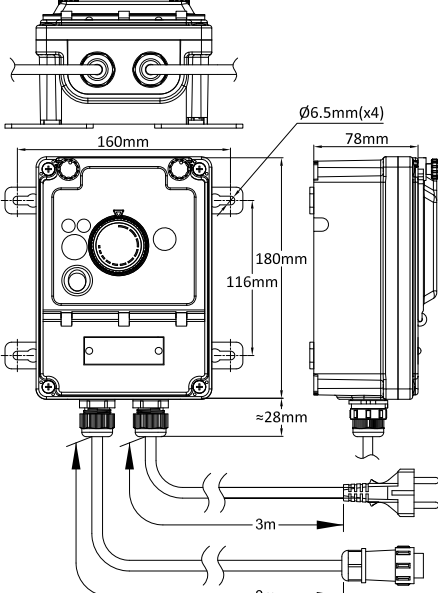
Picture	Drawing	Description
		<p>60 Watts 12V DC Stirrer with 125mm x 125mm stainless steel case, 2" fitting and 350mm shaft, <b>with temperature sensor.</b></p> <p>Reference with <b>NTC</b> sensor</p> <p>9H06012520350N2</p> <p>Reference with <b>Pt100</b> sensor</p> <p>9H06012520350P2</p>
		<p>Stirrer speed adjustment control with 3 meters power supply cord and 3 meters cord and connector for stirrer.</p> <p>Reference</p> <p>Y8WTZ017010000UN</p>

Because of permanent improvement of our products, drawings, descriptions, features used on these data sheets are for guidance only and can be modified without prior advice



# Double digital display liquid temperature controller with a Pt100 500mm long temperature sensing probe for temperature measurement at the centre of containers



Measurement range	Assembly	Immersed length	Type
Configurable	- On drums - On IBC	500mm	<b>Y8WJ-F</b>

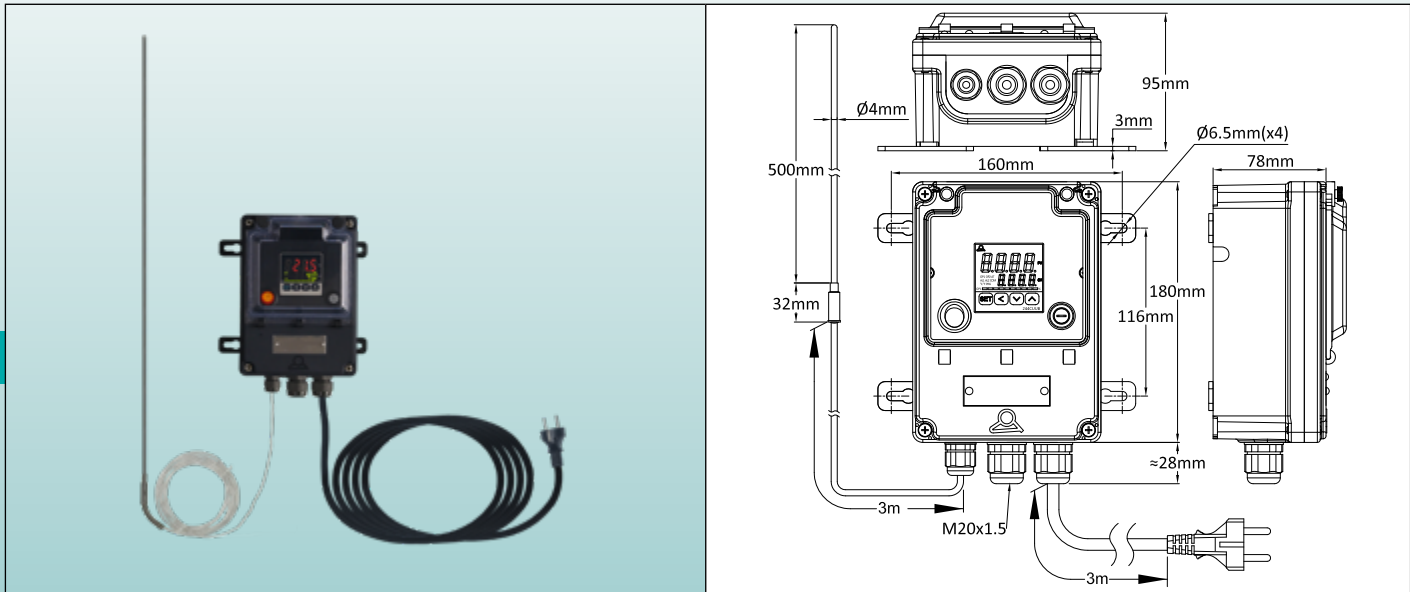

## Main features

The heating of the containers (drums or IBC's) by jacket heaters gives only the indication of the wall temperature which can be up to 20°C higher than the temperature in the center. To know the temperature in the center of the liquid, it is necessary to immerse a temperature probe. This device, with **PID action and Pt100 sensor** allows to measure this temperature in the center, and to use it **to control the heating process according to this temperature**, and also to trigger a high or low alarm.

**The use of this system to control the temperature requires a jacket heater equipped with a surface temperature limiter.**

**Enclosure:** IP69K, reinforced PA66, with polycarbonate window access. Sealable cover and window.

**Wall mounting:** Four removable and rotatable legs.

**Electrical connection:** On internal connection block for the relay output. With 3 meters power supply cord, 3x1.5mm<sup>2</sup>, rubber insulated, euro plug (euro plug in option)

**Switching devices:** Main power illuminated switch and safety fuse.

**Controller:** Double display, of process value and of set-point

**Action:** PID with automatic parameters adjustment by auto-tune function.

**Sensor input:** Pt100

**Power output:** 20A 230V solid state relay.

**Alarm:** 3A 230V relay.

**Display:** 4 digits display configurable in °C or °F

**Power supply:** AC 220-230V 50-60Hz.

**Accuracy:** ±1°C (±2°F) or 0.3% ES± one digit.

**Self-testing:** open sensor circuit.

**Ambient temperature:** -10 to 60°C, 20 to 85% relative humidity, non-condensing.

**Temperature display range:** Configurable

**Resolution:** 0.1°.

## Main references

Pt100 x 500mm probe, with 3 meters long power supply cord, 3x1.5mm <sup>2</sup> , euro plug	No temperature sensor, for other model of temperature sensor use, with power supply cord, 3 meters long 3x1.5mm <sup>2</sup> , euro plug	Pt100 x 500mm probe, with 3 meters long power supply cord, 3x1.5mm <sup>2</sup> , euro plug and 3 meters cord and connector for standard jacket heater
Y8WJW021D100GFUQ	Y8WJW021D1000FUQ	Y8WJW021D100GFUS
*UL plug: replace the last character Q by R	*UL plug: replace the last character Q by R	*Fiche UL: remplacez le dernier caractère S par T

Because of permanent improvement of our products, drawings, descriptions, features used on these data sheets are for guidance only and can be modified without prior advice

# 500mm long immersed probe temperature sensors, NTC or Pt100 for drums and IBC



Because of permanent improvement of our products, drawings, descriptions, features used on these data sheets are for guidance only and can be modified without prior advice

Sensors type	Assembly	Immersed length	Type
NTC and Pt100	- On drums - On IBC	500mm	<b>TNR80 TSR80</b>

## Main features

These temperature sensors, which can be mounted on the 2" holes of the drums, have been developed to ensure a good positioning with the end of the sensor near the center of the drum, but also the air communication to the atmospheric pressure. These models can also be mounted on IBCs of 1000 liters or more, by making an appropriate diameter hole in the filling plastic cap. They exist with NTC sensor and Pt100 sensor and are compatible with the control devices described in the previous pages using the same type of sensors. Their immersed length is 500mm, but other lengths can be made on request.

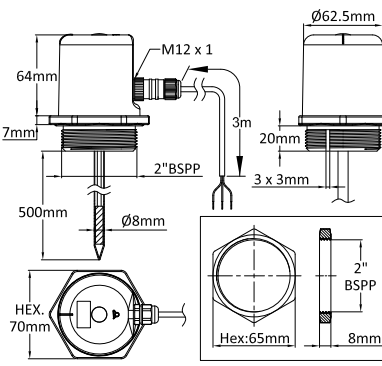
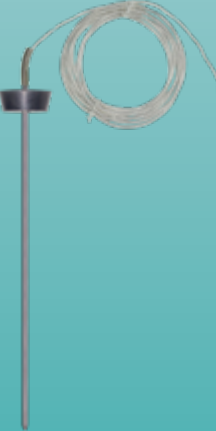
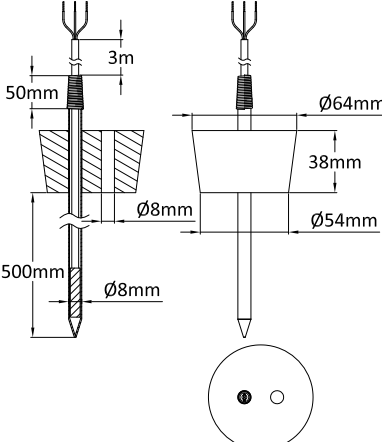
Picture	Drawing	Description				
		<p>Waterproof PA66 connection box, 2" BSPP brass fitting with air intake, 3 meters cable. The connector on the connection box allows separate the cable temperature sensor to facilitate screwing. 2" brass nut included.</p> <table border="1" style="width: 100%;"> <tr> <td style="text-align: center;">500mm type with NTC sensor</td> </tr> <tr> <td style="text-align: center;">TNR80E00I300B1K6</td> </tr> <tr> <td style="text-align: center;">500mm type with Pt100 sensor</td> </tr> <tr> <td style="text-align: center;">TSR80E00I300BBK6</td> </tr> </table>	500mm type with NTC sensor	TNR80E00I300B1K6	500mm type with Pt100 sensor	TSR80E00I300BBK6
500mm type with NTC sensor						
TNR80E00I300B1K6						
500mm type with Pt100 sensor						
TSR80E00I300BBK6						
		<p>Single probe, with air intake, sliding in a silicone cap, can be used on glass, plastic or metal containers</p> <table border="1" style="width: 100%;"> <tr> <td style="text-align: center;">500mm type with NTC sensor</td> </tr> <tr> <td style="text-align: center;">TNR80E00I300S1K6</td> </tr> <tr> <td style="text-align: center;">500mm type with Pt100 sensor</td> </tr> <tr> <td style="text-align: center;">TSR80E00I300SBK6</td> </tr> </table>	500mm type with NTC sensor	TNR80E00I300S1K6	500mm type with Pt100 sensor	TSR80E00I300SBK6
500mm type with NTC sensor						
TNR80E00I300S1K6						
500mm type with Pt100 sensor						
TSR80E00I300SBK6						

# 20mA, 20A ground fault and overcurrent breaker



Enclosure	Overcurrent sensitivity	Current leaks sensitivity	Type
IP69K	20A	20mA	<b>Y8WSY</b>

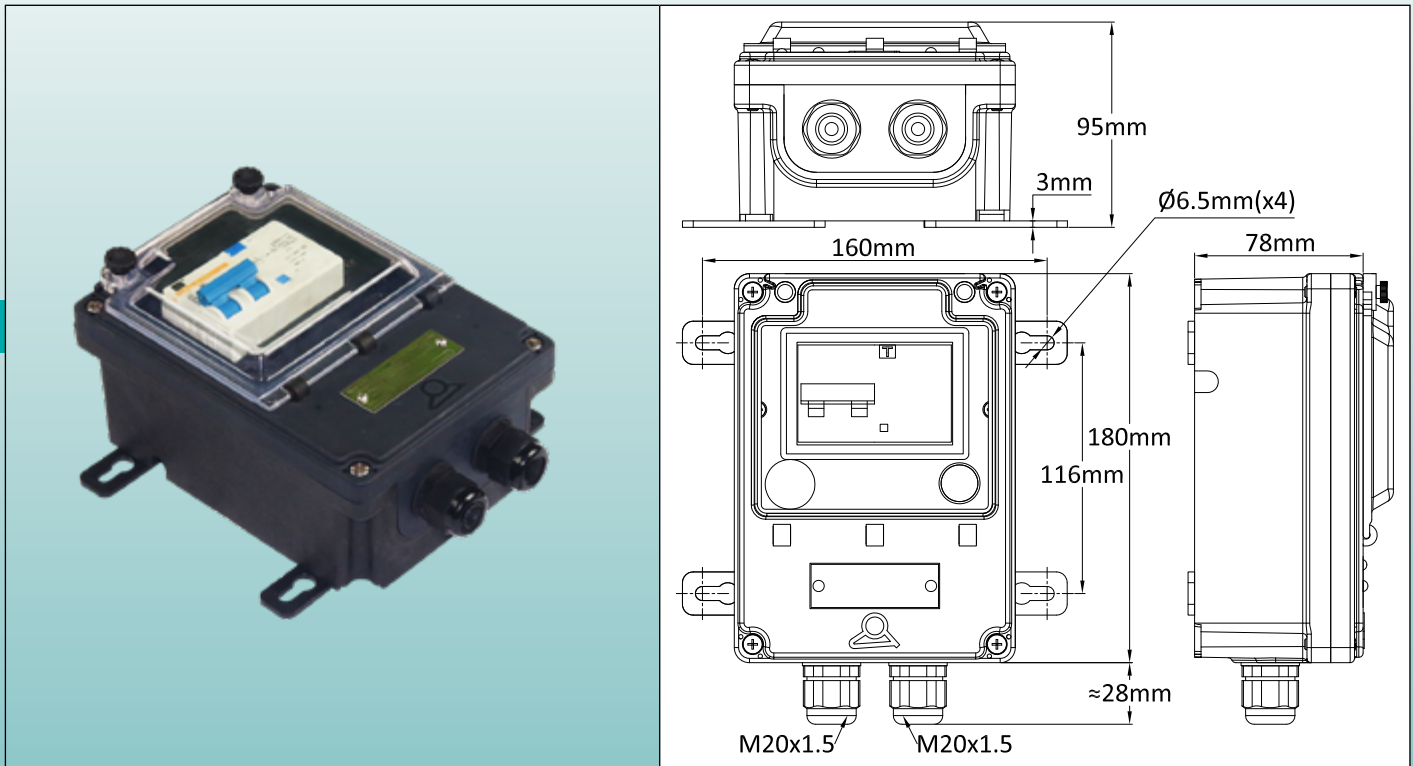

## Main features

The GFCI is a device that combines overcurrent and short circuit protection with current leakage protection. The purpose of overcurrent protection is to protect equipment, and protection against leakage is intended to protect people against the risk of electric shock. In Jacket and blanket heaters, every precaution is taken to avoid these risks. But there may be exceptional circumstances that may produce short circuits or leaks. This can be for example a very hot liquid overflow, the piercing of the cover or a power cord by a sharp metal object, or simply the disconnection of a conductor due to a bad tightening of electrical terminals. We therefore recommend the use of this device, waterproof, at the head of the power line of the jacket or blanket heater.

**Enclosure:** IP69K, reinforced PA66, with polycarbonate window access. Sealable cover and window.

**Wall mounting:** Four removable and rotatable legs.

**Electrical connection:** On 6mm<sup>2</sup> internal connection block.

**Cable glands:** Two M20 cable glands in PA66.

**Current leakage sensitivity:** 20mA (difference of current measured between the phase line and neutral line).

**Overcurrent sensitivity:** 20A.

**Nominal voltage:** 220-240V.

**Number of poles:** 2.

## Main reference

Y8WSY060000000U9

Because of permanent improvement of our products, drawings, descriptions, features used on these data sheets are for guidance only and can be modified without prior advice



Because of permanent improvement of our products, drawings, descriptions, features used on these data sheets are for guidance only and can be modified without prior advice

# Special products made on order



Because of permanent improvement of our products, drawings, descriptions, features used on these data sheets are for guidance only and can be modified without prior advice



# Examples of product made on customer specification



Because of permanent improvement of our products, drawings, descriptions, features used on these data sheets are for guidance only and can be modified without prior advice

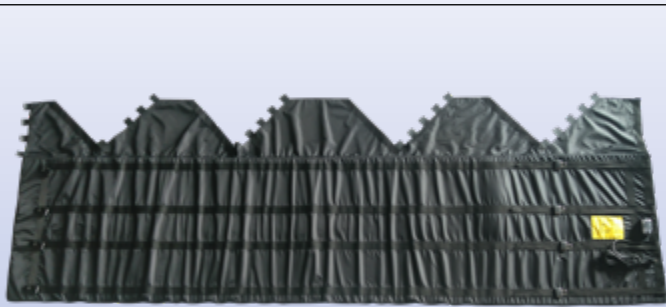

Jacket heater with built in lid



Flat blanket heater



Heating belt for beer home brewing



Reduced heating belt for drums temperature holding



Demountable flexible drying ovens for IBC and drums



Rigid enveloping ovens, for fast heating of barrels by infra-red



Because of permanent improvement of our products, drawings, descriptions, features used on these data sheets are for guidance only and can be modified without prior advice





# ULTIMHEAT

## HEAT & CONTROLS



Catalogues collection on  
[www.ultimheat.com](http://www.ultimheat.com)

**Electromechanical components & OEM heating sub-assemblies manufacturer**

- Mechanical thermostats
- Mechanical safeties single & three poles
- ATEX thermostats & safeties
- Flow through liquid heaters
- Immersion heaters
- Heating elements for air and liquid
- Connection blocks
- Housings for corrosive environments
- Flow switches
- Level switches
- Pressure switches and air switches
- Fusible links and fire detection mechanisms
- Tracing equipment
- **Taylor made solutions**

# Q&A: INDUSTRIAL JACKETS FOR PLASTIC & GLASS TAINERS